

GEAR PUMP MANUFACTURING

Getting the World into Gear

Bearing Range

SERIES: 120; 125; 130; 131; 150; 151; 175; 176

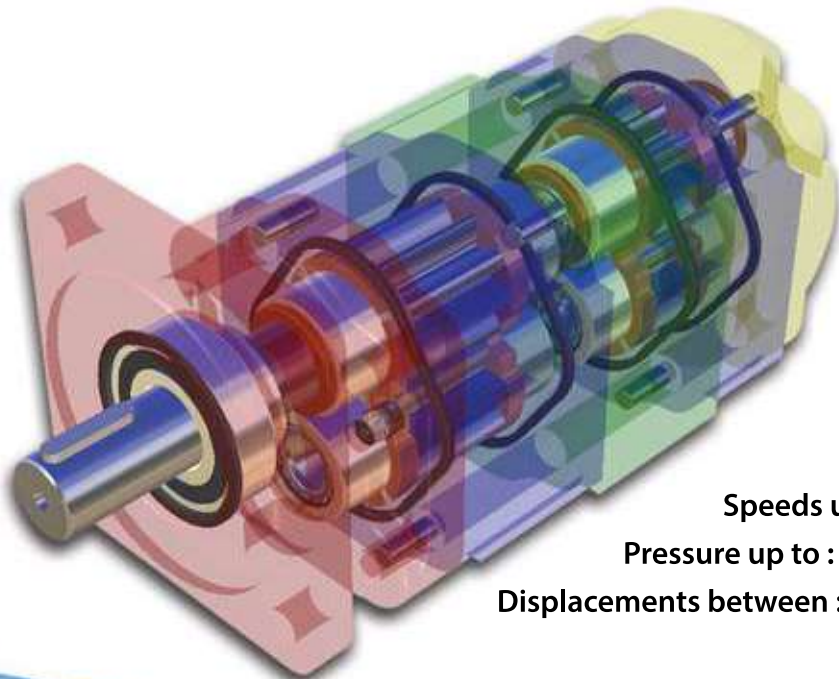

HYDRAULIC:

- PUMPS
- MOTORS
- FLOW DIVIDERS
- ADD-A-PUMPS
- SPARE PARTS

Speeds up to : 2400 RPM

Pressure up to : 205 BAR

Displacements between : 16 cc/rev - 200 cc/rev

Complete product range:

BEARING PUMPS

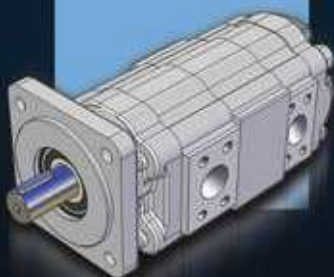

BUSHING PUMPS

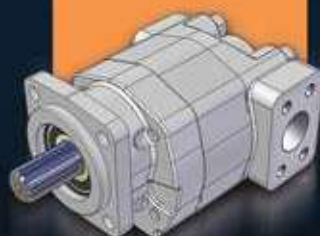

PTO GEAR PUMPS



PTO PISTON PUMPS

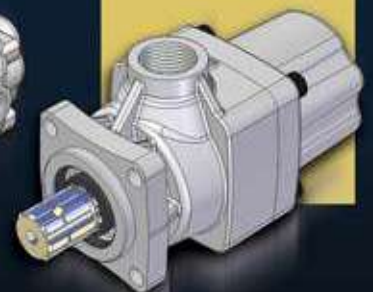

QUICK REFERENCE EXPLODED VIEW A-W

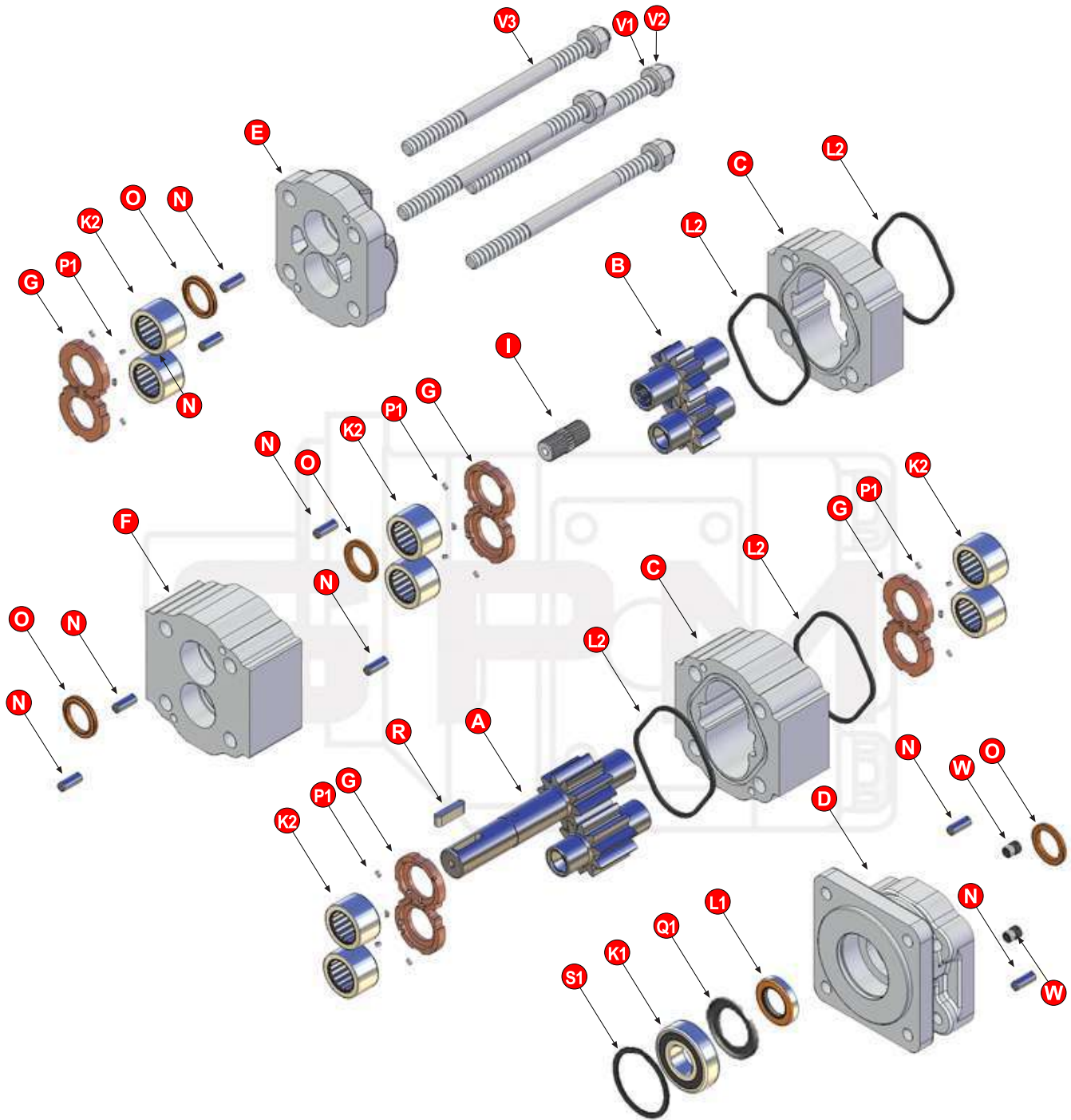

**REFER TO
QUICK
REFERENCE
CHART
FOR
VARIOUS
OPTIONS
AVAILABLE**

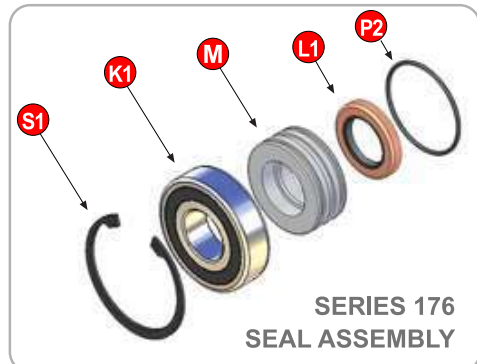
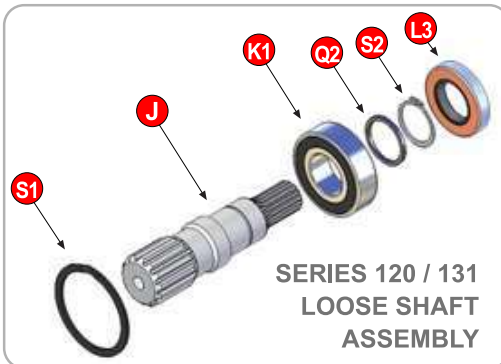

PUMP & MOTOR SPECIFICATIONS

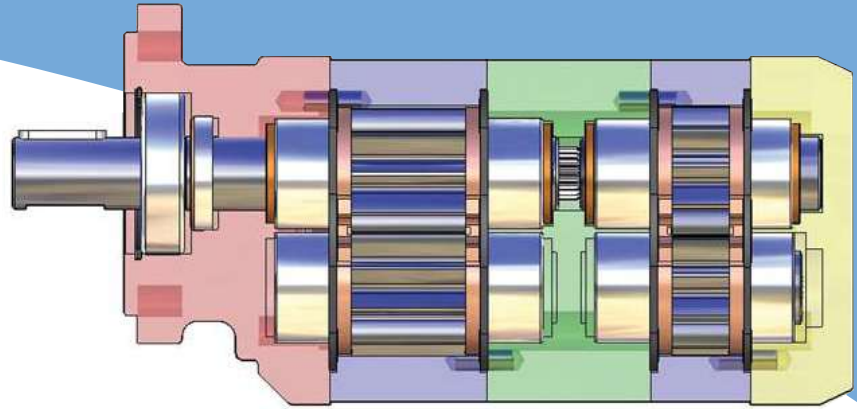

CODE

Manufactured in South Africa

DASH SIZE GEAR WIDTH	-05 0.50"(1/2")	-07 0.75"(3/4")	-10 1.00"(1")	-12 1.25"(1 1/4")	-15 1.50"(1 1/2")	-17 1.75"(1 3/4")	-20 2.00"(2")	-22 2.25"(2 1/4")	-25 2.50"(2 1/2")	-27 2.75"(2 3/4")	-30 3.00"(3")
120											
Gear Housing Width	1.25"(11/4")	1.50"(11.2")	1.75"(13/4")	2.00"(2")	2.25"(21/4")	2.50"(21/2")	2.75"(23/4")				
cc/rev	16.00	24.10	32.20	40.30	48.30	56.40	64.50				
Lpm (at 1000rpm)	16.00	24.10	32.20	40.30	48.30	56.40	64.50				
cu in (cu in/rev)	0.99	1.48	1.97	2.46	2.96	3.45	3.94				
US gpm (at 1000rpm)	4.23	6.37	8.51	10.65	12.76	14.90	17.04				
Max Pressure (bar)	205	205	205	205	205	170	170				
Max Pressure (psi)	3000	3000	3000	3000	3000	2500	2500				
Max Speed (rpm)	2400	2400	2400	2400	2400	2400	2400				
Pump Weight (kg)	10.80	11.30	11.80	12.50	13.20	13.80	14.70				
Additional sect add (kg)	9.50	9.90	10.40	10.90	11.30	11.80	12.70				
125											
Gear Housing Width	1.25"(11/4")	1.50"(11.2")	1.75"(13/4")	2.00"(2")	2.25"(21/4")	2.50"(21/2")	2.75"(23/4")	3.00"(3")	3.25"(31/4")		
cc/rev	20.80	31.20	41.70	52.10	62.60	73.00	83.50	94.00	104.40		
Lpm (at 1000rpm)	20.80	31.20	41.70	52.10	62.60	73.00	83.50	94.00	104.40		
cu in (cu in/rev)	1.28	1.91	2.55	3.19	3.82	4.46	5.10	5.74	6.38		
US gpm (at 1000rpm)	5.50	8.24	11.02	13.76	16.54	19.29	22.06	24.84	27.58		
Max Pressure (bar)	170	170	170	170	170	153	153	138	138		
Max Pressure (psi)	2500	2500	2500	2500	2500	2250	2250	2000	2000		
Max Speed (rpm)	2400	2400	2400	2400	2400	2400	2400	2400	2400		
Pump Weight (kg)	17.00	17.00	17.00	17.50	18.00	19.00	19.50	22.00	22.50		
Additional sect add (kg)	17.00	17.00	17.00	17.50	18.00	19.00	19.50	22.00	22.50		
130 131											
Gear Housing Width	1.25"(11/4")	1.50"(11.2")	1.75"(13/4")	2.00"(2")	2.25"(21/4")	2.50"(21/2")	2.75"(23/4")	3.00"(3")	3.25"(31/4")		
cc/rev	16.00	24.10	32.20	40.30	48.30	56.40	64.50	72.60	80.00		
Lpm (at 1000rpm)	16.00	24.10	32.20	40.30	48.30	56.40	64.50	72.60	80.00		
cu in (cu in/rev)	0.99	1.48	1.97	2.46	2.96	3.45	3.94	4.43	4.92		
US gpm (at 1000rpm)	4.23	6.37	8.51	10.65	12.76	14.90	17.04	19.18	21.14		
Max Pressure (bar)	170/205	170/205	170/205	170/205	170/205	153/170	153/170	138/153	138/153		
Max Pressure (psi)	2500/3000	2500/3000	2500/3000	2500/3000	2500/3000	2250/2500	2250/2500	2000/2250	2000/2250		
Max Speed (rpm)	2400	2400	2400	2400	2400	2400	2400	2400	2400		
Pump Weight (kg)	15.00	15.00	15.00	15.50	16.00	16.50	17.00	17.50	18.00		
Additional sect add (kg)	12.00	12.00	12.00	12.50	13.00	14.00	14.50	15.00	15.50		
150 151											
Gear Housing Width	1.25"(11/4")	1.50"(11.2")	1.75"(13/4")	2.00"(2")	2.25"(21/4")	2.50"(21/2")	2.75"(23/4")	3.00"(3")	3.25"(31/4")		
cc/rev	20.80	31.20	41.70	52.10	62.60	73.00	83.50	94.00	104.40		
Lpm (at 1000rpm)	20.80	31.20	41.70	52.10	62.60	73.00	83.50	94.00	104.40		
cu in (cu in/rev)	1.28	1.91	2.55	3.19	3.82	4.46	5.10	5.74	6.38		
US gpm (at 1000rpm)	5.50	8.24	11.02	13.76	16.54	19.29	22.06	24.84	27.58		
Max Pressure (bar)	170/205	170/205	170/205	170/205	170/205	153/170	153/170	138/153	138/153		
Max Pressure (psi)	2500/3000	2500/3000	2500/3000	2500/3000	2500/3000	2250/2500	2250/2500	2000/2250	2000/2250		
Max Speed (rpm)	2400	2400	2400	2400	2400	2400	2400	2400	2400		
Pump Weight (kg)	17.00	17.00	17.00	17.50	18.00	19.00	19.50	22.00	22.50		
Additional sect add (kg)	17.00	17.00	17.00	17.50	18.00	19.00	19.50	22.00	22.50		
175 176											
Gear Housing Width		1.75"(13/4")	2.00"(2")	2.25"(21/4")	2.50"(21/2")	2.75"(23/4")	3.00"(3")	3.25"(31/4")	3.50"(31/2")	3.75"(33/4")	4.00"(4")
cc/rev		50.30	67.10	84.00	100.60	117.50	134.30	151.00	168.00	184.50	200.00
Lpm (at 1000rpm)		50.30	67.10	84.00	100.60	117.50	134.30	151.00	168.00	184.50	200.00
cu in (cu in/rev)		3.07	4.09	5.13	6.14	7.17	8.20	9.21	10.25	11.28	12.30
US gpm (at 1000rpm)		13.29	17.73	22.19	26.58	31.04	35.48	39.89	44.39	48.75	52.84
Max Pressure (bar)		170/205	170/205	170/205	170/205	170/205	170/205	153/170	153/170	138/153	138/153
Max Pressure (psi)		2500/3000	2500/3000	2500/3000	2500/3000	2500/3000	2500/3000	2250/2500	2250/2500	2000/2250	2000/2250
Max Speed (rpm)		2400	2400	2400	2400	2400	2400	2400	2400	2400	2400
Pump Weight (kg)		33.00	33.00	34.00	35.00	36.00	37.00	38.00	39.00	40.00	41.00
Additional sect add (kg)		33.00	33.00	34.00	35.00	36.00	37.00	38.00	39.00	40.00	41.00

THE ABOVE DATA ARE AVERAGE RESULTS BASED ON A SERIES OF TESTS AND ARE NOT NECESSARILY REPRESENTATIVE OF ANY SINGLE UNIT. GEAR PUMP MANUFACTURING RESERVES THE RIGHT TO AMEND THE TECHNICAL DATA WITHOUT NOTICE.

Useful Formulae	To Convert	Inches	Bar	Cu in/rev	US GPM	US GPM	kg
	Into	Millimeters	Psi	cc/rev	Cu In/rev	cc/rev	lbs
	Multiply by	25.4	14.5	16.39	2.31	3.785	2.205

GP = PUMP
GM = MOTOR
GF = FLOW DIVIDER
GA = ADD ON
GB = STEP DOWN
GZ = PUMP / MOTOR COMBO

QUICK REFERENCE - Parts list **A** to **J**

	120	125	131	151	176
SOLID SHAFT GEAR SET					
7/8" KEY SAE B7/8" KEY SAE B	ADD-131-??		ADD-131-??		
1" KEY SAE BB	AED-131-??		AED-131-??	ATD-151-??	
1 5/16" KEY with 7/8" UNF thread	ATH-131-??		ATH-131-??		
1 1/4" KEY SAE C				ASD-151-??	AAL-176-??
13 SPLINE 7/8" SAE B	ABD-131-??		ABD-131-??	AVD-151-??	
13 SPLINE 7/8" SHORT SAE B	ABD-131-4-??		ABD-131-4-??	AVD-151-4-??	
14 SPLINE 1 1/4" SAE C				APD-151-??	ANE-176-??
14 SPLINE 1 1/4" SHORT SAE C				APD-151-4-??	
15 SPLINE 1" SAE BB	AAU-131-??		AAU-131-??	AAT-151-??	
****GP110 DUMP PUMP				ADE-110-??	
****GP151 TWINSHAFT				AKE-113-??	
****GP112 DUMP PUMP				AVD-151-1-??	
LOOSE GEAR SETS					
**Substitute ?? with Gear Width Code					
STANDARD	BV-131-??	BKA-125-??	BV-131-??	BMA-151-??	BPA-176-??
****SERIES 115				BBA-115-??	
****SERIES 137X				BJA-137-??	
GEAR HOUSINGS					
**Substitute ?? with Gear Width Code					
PUMP	CRD-120-??	CMA-151-??	CRA-131-??	CMA-151-??	CSA-176-??
MOTOR	CRD-120-??	CMA-151-??	CRA-131-??	CMA-151-??	CSA-176-??
PUMP - BI ROTATION				CG-151-??-BI	
****GP110/GP112 DUMP PUMP				CC-110-??	
SHAFT END COVERS					
**Substitute ?? with Gear Width Code					
4 BOLT ROUND		DCB-125-3			
6 BOLT ROUND	DFD-120	DCB-125	DFB-131		
2 BOLT 3.25" SAE A	DWD-120		DWB-131		
2 BOLT 4" SAE B	DGD-120	DUA-125	DGB-131	DRB-151	
2 BOLT 4" SAE B SHORT	DGD-120-SH		DGB-131-SH		
2 BOLT 5" SAE C		DYA-125		DNB-151	DVB-176
4 BOLT 4" SAE B	DED-120	DTA-120	DEB-131	DHB-151	DSB-176
4 BOLT 5" SAE C		DXA-125	DPB-131	DKB-151	DTB-176
4 BOLT 6" SAE D					DUB-176
2/4 BOLT 4" SAE B	DDB-120-4			DDB-151-4	
2/4 BOLT 4" SAE B SHORT				DDB-151-4-SH	
ADD-A-PUMP			DDC-131/131		DPB-176/131
PAD MOUNT PUMP		DSA-125		DMB-151	
CHELSEA	DCD-120				
****GP151 TWINSHAFT PAD MOUNT				DHU-113	
****GP110 DUMP PUMP				DC-110	
PORT END COVERS					
STANDARD	EXD-120	EZA-151	EXA-131	EZA-151	EYA-176
PORTED 4 PORT			EXA-131-4	EZA-151-4	
BI-ROTATION				EG-151-BI	
ADD-A-PUMP STD			EPB-131/131	EPB-151/131	EPB-176/131
****GP151 TWINSHAFT 1.5NPT X 0.75ODT				EHU-151	
****GP151 TWINSHAFT 1.5NPT X 1.00ODT				EHV-151	
BEARING CARRIERS					
STANDARD	FVD-120	FKB-125	FVA-131	FTA-151	FZA-176
STANDARD WITH DRAIN			FVA-131-11	FTA-151-11	FZA-176-11
THRUST PLATES					
PUMP	GAA-131	GY-151	GAA-131	GY-151	GBA-176
DRY VALVE BI ROTATION					GBA-176-BI
DRY VALVE UNI ROTATION					GBA-176-UNI
****SERIES 115				GU-115	
****SERIES 137X				GX-137	
****GP110 DUMP PUMP				GC-110	
CONNECTING SHAFTS					
STANDARD	IZA-131	ITA-125	IZA-131	IYA-151	IAB-176
ADD-A-PUMP			IAF-131/131	IAD-151/131	IAH-176/131
ADD-A-PUMP				IPB-151/151	
DIN/SAE B COUPLING	I-DIN/SAE B		I-DIN/SAE B	I-DIN/SAE B	
LOOSE SHAFTS					
3/4" KEY	JAV-131		JAV-131		
7/8" KEY	JAK-131	JWB-125	JAK-131	JAB-151	
7/8" KEY WITH EXT THREAD	JAX-131		JAX-131		
7/8" KEY LONG	JAK-131-L		JAK-131-L		
1" KEY	JED-131	JHB-125	JED-131	JAE-151	
1 1/8" KEY	JMT-131		JMT-131	JGT-151	
1 1/4" KEY	JAW-131	JRB-125	JAW-131	JAF-151	JAL-176
1 1/4" KEY LONG					JAL-176-L
1 1/4" KEY LONG DOUBLE BRG		JDB-125			
1 3/4" KEY UCHIDA					JUC-176
1 3/4" KEY LONG					JKB-176
CAT 910 TAPER W/RUFF	JCA-131		JCA-131		

Bearing Range

QUICK REFERENCE - Parts list **J** to **W**

	120	125	131	151	176
LOOSE SHAFTS....cont/					
6 SPLINE 1"	JAM-131	JHC-125	JAM-131	JAN-151	
6 SPLINE 1 1/4"				JSX-151	
8 SPLINE DIN	JDI-131		JDI-131		
9 SPLINE 5/8"	JAI-131		JAI-131		
11 SPLINE 3/4"	JDV-131		JDV-131		
13 SPLINE 7/8"	JAJ-131	JVB-125	JAJ-131	JAD-151	
13 SPLINE 7/8" SHORT	JAJ-131-SH		JAJ-131-SH		
13 SPLINE 7/8" LONG	JSB-131		JSB-131		
13 SPLINE 1 3/4"					JAS-176-SHD
14 SPLINE 1 1/4"	JAH-131	JPB-125	JAH-131	JAG-151	JAS-176
14 SPLINE 1 1/4" LONG				JAG-151-L	JAS-176-L
15 SPLINE 1"	JAU-131		JAU-131	JAT-151	
BEARINGS / BUSHES					
NEEDLE ROLLER (K2)	KY-131	KS-151	KY-131	KS-151	KR-176
SHAFT BALL BEARING (K1)	KX-131-40	KX-125-8	KX-131-40	KX-151-58	KX-176-59
SEALS					
BODY SEALS	LUB-120-239	LUB-151-244	LUB-131-242	LUB-151-244	LUB-176-252
PUMP SEAL STANDARD	LX-131-16	LX-125-13	LX-131-16	LX-151-17	LX-176-10
MOTOR SEAL STANDARD	LX-131-9	LX-125-3	LX-131-9	LX-151-8	LX-176-1
PUMP SEAL LOOSE SHAFT	LX-131-18		LX-131-18		
MOTOR SEAL LOOSE SHAFT	LX-131-11		LX-131-11		
PUMP SEAL VITON	LX-131V-16	LX-125V-13	LX-131V-16	LX-151V-17	LX-176V-10
RETAINERS					
SEAL RETAINER MOTOR		MAV-125			MRA-176
SEAL RETAINER PUMP		MGA-125			MRA-176
RETAINER NUT PUMP		MW-125			
RETAINER NUT MOTOR		MLA-125			
DOWELS					
STANDARD			NDOWEL-131	NDOWEL-131	NDOWEL-176
BRONZE PRESSURE RING					
RING SEAL	OLB-131-1		OLB-131-1	ONB-151-1	OWB-176-1
SHAFT BUSH		OAH-125			
CONNECTING SHAFT BUSH		OAR-125			
O-RING / POCKET SEALS					
RETAINER O-RING		PL-125-26			PL-176-164
POCKET SEAL	PBA-131-2		PBA-131-2	PBA-131-2	PBA-176-3
ADD-A-PUMP			PL-PB131/131-30		PL-PB176/131-159
SPACERS					
SEAL SPACER	QAE-131	QSA-125	QAE-131	QAC-151	
INTERNAL SPACER		QTA-125-?		QVB-151-1	
BEARING SPACER	QVB-131-2	QGB-125	QVB-131-2	QVB/AC-151	QVB-176
SHAFT SPACER (CONTI)	QTB-131	QDB-125/QYA-125-1	QTB-131	QTG-151	QAF-176
ADD-A-PUMP			QAK131/131		QAL176/131
KEYS					
3/4" SHAFT	RX-JAV		RX-JAV		
7/8" SHAFT	RX-17		RX-17		
1" SHAFT	RX-13		RX-13		
1 1/8" SHAFT	RX-54		RX-54		
1 1/4" SHAFT	RX-38		RX-38		
1 3/4" SHAFT					RX-45
CAT 910 TAPER (JCA)			RX-606		
SNAP RINGS / CICLIPS					
SHAFT	SX-131-100	SX-125-13	SX-131-100	SX-151-125	SX-176-137
SHAFT END COVER	SX-131-206		SX-131-206	SX-151-283	SX-176-315
FASTENERS					
BOLTS	VBOLT 9/16" X ?	VBOLT 5/8" X ?	VBOLT 5/8" X ?	VBOLT 5/8" X ?	VBOLT 5/8" X ?
NUTS	VNUT 9/16"	VNUT 5/8"	VNUT 5/8"	VNUT 5/8"	VNUT 5/8"
WASHERS	VWASHER 9/16"	VWASHER 5/8"	VWASHER 5/8"	VWASHER 5/8"	VWASHER 5/8"
STUDS 06"-11" EXTENDED THREAD ONE SIDE	VSTUD 9/16"X6-11	VSTUD 5/8"X6-11	VSTUD 5/8"X6-11	VSTUD 5/8"X6-11	VSTUD 5/8"X6-11
STUDS 11"-16" EXTENDED THREAD ONE SIDE	VSTUD 9/16"X11-16	VSTUD 5/8"X11-16	VSTUD 5/8"X11-16	VSTUD 5/8"X11-16	VSTUD 5/8"X11-16
STUDS 16"-21" EXTENDED THREAD ONE SIDE	VSTUD 9/16"X16-21	VSTUD 5/8"X16-21	VSTUD 5/8"X16-21	VSTUD 5/8"X16-21	VSTUD 5/8"X16-21
STUDS 21"-26" EXTENDED THREAD ONE SIDE	VSTUD 9/16"X21-26	VSTUD 5/8"X21-26	VSTUD 5/8"X21-26	VSTUD 5/8"X21-26	VSTUD 5/8"X21-26
SMALL PARTS					
PLUG DRAIN	WX-131-11	WX-131-11	WX-131-11	WX-131-11	WX-131-11
PLUG SHAFT END COVER	WT-131-1391	WT-131-1391	WT-131-1391	WT-131-1391	WT-131-1391
CHECK VALVES	WM-131-1391	WM-131-1391	WM-131-1391	WM-131-1391	WM-131-1391

**Substitute ? with Bolt Length (Imperial)

All product listed herein is product manufactured and/or supplied by Gear Pump Manufacturing (Pty) Limited (GPM), a South African manufacturer and supplier of replacement parts and components.
Commercial Intertech is a registered trademark or copyright of the Parker Hannifin Corporation (Parker). Any reference to this entity, it's trademark, copyright, product or reference number, is for product comparison and reference purposes only and as such, any referral thereto, should not be construed as implying in any way that Parker product is manufactured or supplied by GPM or that GPM is in any way associated with Parker.

Copyright: © 2015 Gear Pump Manufacturing (Pty) Limited. All Rights Reserved. No part of this document may be reproduced in any form or manner without permission.

SABS
ISO 9001

Manufactured in South Africa

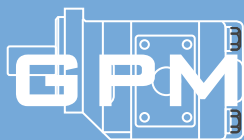

GEAR PUMP MANUFACTURING

Manufacturing Plant (Cape Town)
15 Moody Ave, Epping 1, Cape Town, South Africa

Tel: +27 (0) 21 531 9330

Fax: +27 (0) 21 531 7096

SALES: sales@gearpumps.co.za

TECHNICAL: technical@gearpumps.co.za

Website: www.gearpumps.co.za



REPRESENTED BY:



**Gear Pump
Distributors (UK)**

Unit 14, Aston Fields Trading Estate
18 Sugarbrook Road, Bromsgrove,
Worcestershire B60 3DW
United Kingdom

Phone: +44 (1527) 880 396
Fax: +44 (1527) 880 397
Email: sales@gearpumps.co.uk
Web: www.gearpumps.co.uk

SABS
ISO 9001

Manufactured in South Africa

A MEMBER OF THE **Hudaco** GROUP