



GX-SERIES

GX Series

Bridgeport GX 300

Bridgeport GX 480

Bridgeport GX 510

Bridgeport GX 710

Bridgeport GX 1300

Bridgeport GX 1600



800-843-8801

[WWW.HARDINGE.COM](http://WWW.HARDINGE.COM)

# BRIDGEPORT GX SERIES

The GX Series machining centers are designed and built for a production environment. A unique design allows for these machines to literally overlap one another to better utilize valuable floor space and to promote cell manufacturing. The design allows access to only be necessary from the front and back of the machine allowing you to stack these machines side by side. This type of floor plan and machine design is perfect for automation. Add some robots or a gantry system and you can increase your productivity with virtually no labor costs.

Don't let the compact footprint fool you these machines pack a powerful punch! With 20HP and 99 ft.-lbs. of torque these machines are sure to be a market leader!. These specifications make the GX Series machines ideal for the aerospace, medical, defense, 3C, automotive and other industries who require high-value, complex parts from difficult to machine materials.



## GX 300

- X,Y,Z Travel  
11.80" x 15.76" x 16.94"  
(299.72 x 400.30 x 430.28mm)
- 20 HP (14.92kW) (30min)
- Max Spindle Speed: 7,083 RPM
- 98.8 ft.-lbs (133.95Nm) torque
- Swing Arm ATC: 20-Station
- Dual Auger Conveyor
- FANUC OMD

## GX 480

- X,Y,Z Travel: 19" x 16" x 17"  
(480.60 x 406.40 x 431.80mm)
- 20HP (14.92kW) (1min)
- Spindle Speed: 10,000 RPM
- Swing Arm ATC: 20-Station
- Control: i-Series GX

## GX 510

- X,Y,Z Travel  
20" x 15.76" x 16.94"  
(508 x 400.30 x 430.28mm)
- 20 HP (14.92kW) (30min)
- Max Spindle Speed: 7,083 RPM
- Torque: 98.8 ft.-lbs (133.95Nm)
- Swing Arm ATC: 20-Station
- FANUC OMD



# BRIDGEPORT GX SERIES

## GX 710

- X,Y,Z Travel: 28" x 16" x 17" (711.20 x 406.40 x 431.80mm)
- 20HP (14.92kW) (1min.)
- Spindle Speed: 10,000 RPM
- Swing Arm ATC: 20-Station
- Control: i-Series GX



## GX 1300

- X,Y,Z Travel: 51" x 27.5" x 25" (1295.40 x 698.50 x 635mm)
- 25HP (18.65kW) (30 min.)
- Spindle Speed: 10,000 RPM
- Swing Arm ATC: 30-Station
- Control: i-Series GX
- 50 Taper Option (10k & 6k Gearbox)



## GX 1600

- X,Y,Z Travel: 63" x 27.5" x 25" (1600.20 x 698.50 x 635mm)
- 25 HP (30 min.)
- Spindle Speed: 10,000 RPM
- Swing Arm ATC: 30-Station
- Control: i-Series GX
- 50 Taper Option (10k & 6k Gearbox)



GX-Series vertical machining centers have thousands of installations worldwide. These 40-50 taper spindles VMCs include superior design characteristics to ensure many years of accurate and reliable performance. GX-Series machines are ideal for mold and die manufacturers, aerospace, medical, defense, 3C, automotive, and other industries, requiring high-value, complex parts from difficult to machine materials.

## KEY DIFFERENTIATORS

- Unique design allows machines to be stacked side by side
- Robust spindle with 20 horsepower and 99 ft-lbs of torque
- Heavy-duty linear roller guide-ways
- 20-station swing arm ATC as standard equipment for high production
- Rear chip discharge
- Programmable auto-door
- 8 additional M-codes



# KEY FEATURES

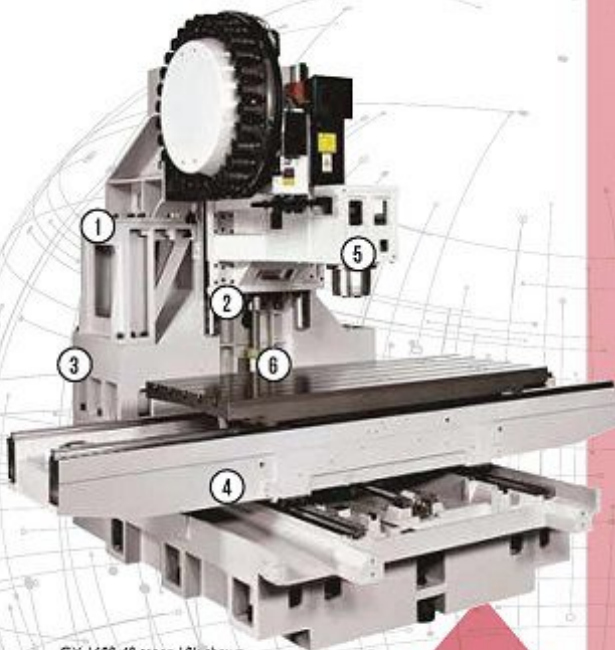

GX 1600 40 taper, 10K shown

## HEAVY DUTY LINEAR GUIDEWAYS, BALLSCREWS AND AXIS DRIVES

Wide-spaced, oversized linear guideways provide optimum stiffness with less friction, less heat and less thermal growth for faster traverse rates, longer machine life and greater positioning accuracy. The linear way modules consist of slide members (guide trucks) and linear rails to provide a large load rating, stable accuracy, high rigidity and low friction. The wide spacing between all axes rails provides optimum stiffness for the overall machine structure.

### Ballscrew measurement:

GX 300 1.26" (32mm)	GX 710 1.26" (32mm)
GX 510 1.26" (32mm)	GX 1300 1.77" (45mm)
GX 480 1.26" (32mm)	GX 1600 1.77" (45mm)

- 1** The GX1300 and GX1600 column mount design deflects ATC weight overhang, providing superior rigidity and minimized vibration.
- 2** Large high-quality, low maintenance roller guideways on GX 1300 and GX 1600 machines provide greater positioning accuracy and superior finishes very low friction and high stiffness for long machine life. Roller linear guides used on GX 300 and GX 510. Linear guideways featured on GX 480 and GX 710.
- 3** Highly engineered machine structure manufactured from gray cast iron heavily ribbed throughout to ensure high overall rigidity and thermal stability.
- 4** All geometric alignments conform to ISO 230 standards; every machine must pass strict laser and ball-bar tests.
- 5** Best-in-class spindle design incorporates five (5) bearings for superior rigidity and overall spindle life: four (4) angular contact bearings on the front; one (1) roller bearing on the rear.
- 6** Oversized high-class 45mm (1.77") double-end ballscrews fixed and pre-tensioned to provide superior machine accuracy and repeatability (32mm ballscrews on GX 310 and GX 510 (pre-tensioned); 32mm ballscrews on GX 480 and GX 710 models (non pre-tensioned)).

# KEY FEATURES

## LARGE CAPACITY, FAST PERFORMANCE AUTOMATIC TOOL CHANGERS

GX-Series VMCs have a fast tool change time of 2 seconds (Tool-Tool). The design of random bi-directional ATCs and cam type mechanism features accurate, rapid and stable tool change system. 90 degree tool pocket prevents tool dropping. To ensure smooth and vibration-free tool changing, GX 1300 and GX 1600 machines have their tool changer strategically located for minimal transfer of vibration—a unique design feature. All ATCs feature random-access, bi-directional indexing.

## ELIMINATION OF Z-AXIAL MOVEMENT

At high rotational spindle speeds, the mouth of the machine spindle can expand slightly due to centrifugal force. As the machine spindle expands, the conventional toolholder, which under constant draw bar pulling pressure, moves further into the spindle. On high tolerance applications, this slight pull back of the cutter can affect dimensional accuracy of the Z-axis. Pull back can also cause the toolholder to get locked into the machine spindle taper. The face contact provided by the BIG-PLUS Spindle System prevents the toolholder from being drawn back into the machine spindle.

## BIG-PLUS DUAL CONTACT SPINDLE SYSTEM

The BIG-PLUS spindle system assures higher rigidity, stiffness and accuracy of tool holders in high-speed and difficult machining applications. The dual contact precisely positions the toolholder within 1 micron following a tool change.

## USER-FRIENDLY MANUAL GUIDE i SOFTWARE

Manual Guide i is an advanced conversational programming system available on Fanuc Controls. A fully animated version of the operator-generated part program can easily be viewed on the full-color display. Using Manual Guide i ensures that the process is proven prior to actual machining. If desired, the simple push of a button converts the conversational program into a standard G and M-code program. Manual guide Oi is offered on GX480 and GX 710 models.

## FORKARDT ROTARY SOLUTIONS

Forkardt Rotary Systems can be integrated into the GX Series machines, operating in a fully interpolated fashion with the other axes of the machine. The machining center must be configured for immediate or future 4th-axis operation. Refer to brochure 2372 for a complete rotary product offering with dimensions and specifications.



# GX SERIES SPINDLE

## GX 300/510 7080 RPM Spindle

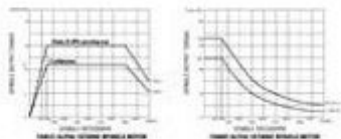

## GX 480/710 10,000 RPM Spindle (standard)

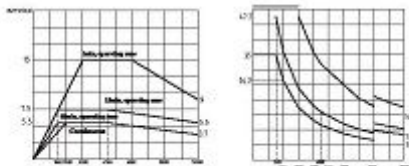

## GX 1300/1600 10,000 RPM Spindle (standard)

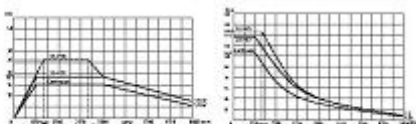

## GX 1300/1600 12,000 RPM Spindle (option)

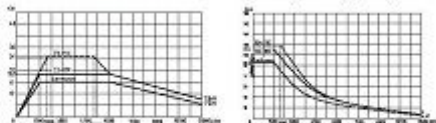

## GX 1300/1600 50 TAPER 10,000 RPM Spindle

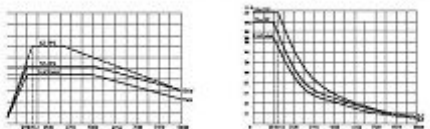

## GX 1300/1600 50 TAPER 6,000 RPM Spindle (Gearbox)

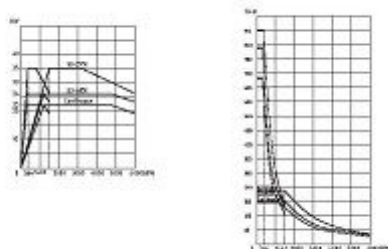

GX-Series machining centers feature a powerful spindle motor for aggressive cutting capabilities. A 15kW (20-hp 1 min) spindle drive is included on GX 300, GX 510, GX 480 and GX 710 machines; and GX 1000 machines feature a 15-kW (20-hp 30min) drive; GX 1300 and GX 1600 machines feature an 18.5-kW (25-hp 30min) drive. The rigid spindle design includes four angular contact bearings at the front and one roller bearing at the rear for optimum performance and long life. The non-contact magnetic encoder design eliminates noise and vibration, while providing more accurate spindle orientation feedback.

The high-speed spindle option is ideal for mold and fixture work when machining hardened materials, as well as high-speed cutting of aluminum or magnesium alloy.

Through-spindle coolant is available as an option to supply coolant to the cutting edge at 20 bar (300 psi and 1000psi on select models), allowing faster speeds, enhanced deep hole drilling and blind pocket milling.

MODEL	POWER	TORQUE	MAX. SPEED	MAX. SPEED option
GX 300	15kW (20hp)	133.95Nm (98.8ft.-lb.)	7,083 rpm	10,000 rpm
GX 480	15kW (20hp)	49Nm (35.8ft.-lb.)	10,000 rpm	—
GX 510	15kW (20hp)	133.95Nm (98.8ft.-lb.)	7,083 rpm	10,000 rpm
GX 710	15kW (20hp)	49Nm (35.8ft.-lb.)	10,000 rpm	—
GX 1300	18.5kW (25hp)	14.1Nm (10.4ft.-lb.)	10,000 rpm	—
GX 1600	18.5kW (25hp)	14.1Nm (10.4ft.-lb.)	10,000 rpm	12,000 rpm



## STANDARD FEATURES

- 10.4" Color LCD  
(8.4" on GX 300, 480, 510 & 710)
- AI Contour Control  
(option on GX 480 & GX 710)
- Manual Guide i (manual guide Oi on GX 480 & GX 710)
- Max Controlled axes 5
- Simultaneous controlled axes 4
- DNC operation with memory card
- Program restart
- Dry run
- Fine Acc & Dec control
- Least input increment  
- 0.001 mm, 0.001 deg.
- Servo control HRV3
- Backlash compensation
- Linear interpolation
- Chamfering and corner rounding
- Coordinate system rotation
- Scaling
- Cylindrical interpolation
- Helical interpolation  
(Circular interpolation plus Max. 2 axes linear interpolation)
- Polar coordinate command
- Circular interpolation  
(Multi-quadrant is possible)
- Programmable mirror image
- Background editing
- Extended editing
- Dynamic graphic display
- Nano interpolation
- Rigid tapping
- Multi language display
- Run hour and parts count display
- Automatic acceleration /deceleration
- Automatic corner override
- Rapid traverse: linear Cutting feed: exponential
- Tool offset pairs,  $\pm 6$  digits, 400 pairs
- Tool length compensation
- Tool offset memory C
- Part program storage length 1280 m
- Number of registered programs 400
- Self-diagnosis function
- Alarm history display
- Operation history display
- Help function
- Stored pitch error compensation
- Sub call
- Custom Macro B
- Additional custom macro variables
- Canned cycles for drilling
- Small hole peck cycle
- Tool life management
- Workpiece coordinate system, G52 - G59
- Addition of workpiece coordinate system 48 pairs
- Automatic tool length measurement
- Inch / Metric
- Embedded Ethernet

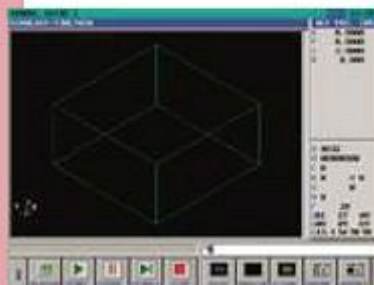

# SPECIFICATIONS

	GX 300	GX 510
<b>AXIS TRAVEL</b>		
X-Axis	11.80" (300mm)	20" (510mm)
Y-Axis	15.8" (400mm)	15.8" (400mm)
Z-Axis	16.9" (430mm)	16.9" (430mm)
<b>POSITIONING</b>		
Rapid Traverse Rates (X,Y,Z Axes)	1,181" / min.	1,181" / min.
Manual Mode (X,Y,Z Axes)	0-354" / min.	0-354" / min.
Acceleration (X,Y,Z Axes)	190 in/s <sup>2</sup> (4.8m/s <sup>2</sup> )	190 in/s <sup>2</sup> (4.8m/s <sup>2</sup> )
Minimum Increment	0.00004"	0.00004"
Ball Screw Diameter and Pitch (X,Y,Z Axes)	1.26" x 10 pitch (32mm)	1.26" x 10 pitch (32mm)
<b>SPINDLE</b>		
Speed Range	7,083RPM (10,000 option)	7,083RPM (10,000 option)
Motor HP/30 min. Rating	20HP (15kW)	20HP (15kW)
Torque	133.95Nm (98.8ft/lbs)	133.95Nm (98.8ft/lbs)
Retention Force	1,763lbs	1,763lbs
Taper	No. 40	No. 40
Tool Holder	CT40	CT40
Distance from table to Gauge Plane	5.9" min-22.8"	5.9" min-22.8"
<b>WORKTABLE</b>		
Working Surface	23.6" x 15.8" (600 x 400mm)	23.6" x 15.8" (600 x 400mm)
Table Load	396lbs. (180kg)	550lbs. (250kg)
Number of T-Slots	3	3
T-Slot Size	0.70" (18mm)	0.70" (18mm)
Fanuc	0iMD	0iMD
<b>AUTOMATIC TOOL CHANGER - Swing Arm</b>		
Magazine Capacity	20 Tools	20 Tools
Tool Select by Shortest Path & Random Select	Bi-Directional	Bi-Directional
Max. Tool Diameter (Full Drum)	3.15" (80mm)	3.15" (80mm)
Max. Tool Diameter (Adjacent Rodets Empty)	5.9" (150mm)	5.9" (150mm)
Max. Tool Length	8.86" (225mm)	8.86" (225mm)
Max. Tool Weight	13.2lbs. (6kg)	13.2lbs. (6kg)
Random Tool Change Time (tool to tool/c to c)	2.5/4.5 sec.	2.5/4.5 sec.
<b>COOLANT FACILITIES</b>		
Coolant Capacity	31.7 Gallons (120L)	31.7 Gallons (120L)
<b>ACCURACY SPECIFICATIONS (ISO - 230-2)</b>		
Positioning	0.0002" (.005mm)	0.0002" (.005mm)
Repeatability	0.00011" (.0025mm)	0.00011" (.0025mm)
<b>MISCELLANEOUS</b>		
Power Supply Requirement	220v3Phase/67FLA	220v3Phase/67FLA
Program Resolution	0.0001" (0.001mm)	0.0001" (0.001mm)
Machine Lubrication	Grease	Grease
Machine Communication	RS-232-C, PCMCIA Card & USB	RS-232-C, PCMCIA Card & USB
<b>MACHINE DIMENSIONS</b>		
Length	57.09" (1,450mm)	60.04" (1,524mm)
Depth	100.87" (2,562mm)	100.87" (2,562mm)
Height	93.35" (2,371mm)	93.35" (2,371mm)
Approx. Weight	10,913lbs (4,950kg)	11,244lbs (5,100kg)



# SPECIFICATIONS

GX 480	
<b>AXIS TRAVEL</b>	
X-Axis	18.90" (480mm)
Y-Axis	15.80" (400mm)
Z-Axis	16.90" (430mm)
Table surface to spindle gauge distance	5.91"-22.83" (150-580mm)
<b>POSITIONING</b>	
Auto Mode (XYZ Axes)	36m/min (1,417ipm)
Feedrate Range (XYZ Axes)	0.004-23.2m/min (0.1-590ipm)
Minimum Increment	0.00004" (0.00001mm)
Ball Screw Diameter and Pitch (X & Y Axes)	1.26" x 0.63" (32 x 16mm)
Ball Screw Diameter and Pitch (Z Axis)	1.26" x 0.472" (32 x 12mm)
<b>SPINDLE</b>	
Speed Belted	10,000RPM
Motor Power Rating CT/30/15/1min.	7.5/10/20HP (5.5/7.5/15kW)
Torque (53-60%)	35ft/lbs (47.7Nm) (1500RPM)
Retention Force	6,375N (1,430lbf)
Spindle Taper	No. 40, BIG PLUS®
Tool Holder	CT40 or BT40
<b>WORKTABLE</b>	
Working Surface	23.6" x 15.8" (600 x 400mm)
Table Load	66 lbs (300kg)
Number of T-Slots	3
T-Slot Size	0.551" (14mm)
T-Slot Center Dimension	4.92" (125mm)
<b>CONTROL</b>	
FANUC	CIMD
<b>AUTOMATIC TOOL CHANGER - Swing Arm</b>	
Magazine Capacity	20 Tools
Tool Select by Shortest Path & Random Select	8i-Directional
Max Tool Diameter (Full Drum)	3.15" (80mm)
Max Tool Diameter (Adjacent Pockets Empty)	5.9" (150mm)
Max Tool Length	7.48" (190mm)
Max Tool Weight	15.7lbs (7kg)
Random Tool Change Time (tool to tool/c to c)	4.5 sec.
<b>COOLANT FACILITIES</b>	
Coolant Capacity	31.7 Gallons (120L)
<b>ACCURACY SPECIFICATIONS (ISO - 230-2)</b>	
Positioning	0.0004" (010mm)
Repeatability	0.0002" (005mm)
<b>MISCELLANEOUS</b>	
Power Supply Requirement	64FLA
Electrical Supply	50 or 60 Hz
Voltage	220
Compressed Air Requirement	70 psi (5kg/cm2)
<b>MACHINE DIMENSIONS</b>	
Length	62.01" (1,575mm)
Depth	83.35" (2,168mm)
Height	82.20" (2,088mm)
Approx. Weight	6,204lbs (2820kg)



# SPECIFICATIONS

	GX 710	GX 1300
<b>ADJUSTABLE</b>		
X-Axis	27.95" (710mm)	51.89" (1300mm)
Y-Axis	15.9" (400mm)	27.00" (700mm)
Z-Axis	16.9" (430mm)	25" (635mm)
Table surface to spindle gauge distance	5.91" (22.93") (150-160mm)	5.24" (30.24") (133-149mm)
<b>POSITIONING</b>		
Auto Mode (X, Y, Z Axis)	36m/min (1,141.7ipm)	36m/min (1,141.7ipm)
Feedrate Range (X, Y, Z Axis)	0.004-23.2m/min (0.1-590ipm)	0.0025-12m/min (0.1-472ipm)
Minimum Increment	0.00004" (0.00001mm)	0.0004" (0.001mm)
Ball Screw Diameter and Pitch (X & Y Axis)	1.26" x 0.47" (32 x 12mm)	1.37" x 0.472" (45 x 12mm)
Ball Screw Diameter and Pitch (Z Axis)	1.26" x 0.472" (32 x 12mm)	1.37" x 0.472" (45 x 12mm)
<b>SPINDLE</b>		
Speed, Rated	10,000RPM	10,000RPM
Motor Power Rating, CT/30/15/1min.	7.5/10/20HP (5.5/7.5/19kW)	15/20/24.8HP (11/15/26kW)
Torque (S3-60%)	39ft-lbs (49.7Nm)(1900RPM)	109ft-lbs (147Nm)
Retention Force	6.375N (1.43lbf)	7.3295N (1.63lbf)
Spindle Taper	No. 40, B/G PLUS*	No. 40, B/G PLUS*
Tool Holder	CT40 or BT40	CT40 or BT40
<b>WORKTABLE</b>		
Working Surface	31.5" x 15.8" (800 x 400mm)	56" x 27.55" (1425 x 700mm)
Table Load	66lbs (300kg)	3,200lbs (1,500kg)
Number of T-Slots	3	5
T-Slot Size	0.551" (14mm)	0.708" (18mm)
T-Slot Center Dimension	4.92" (125mm)	4.92" (125mm)
<b>CONTROL</b>		
PLC	OMC	OMC
<b>AUTOMATIC TOOL CHANGER - Swing Arm</b>		
Magazine Capacity	20 Tools	30 Tools (40 Opt)
Tool Select by Shortest Path & Random Select	8-Directional	8-Directional
Max Tool Diameter (Full Drum)	3.15" (80mm)	3" (76.2mm)
Max Tool Diameter (Adjacent Pockets Empty)	5.9" (150mm)	5.9" (150mm)
Max Tool Length	7.48" (190mm)	12.70" (320mm)
Max Tool Weight	15.7lbs (7kg)	17.6lbs (8kg)
Random Tool Change Time (tool to tool) (to c)	4.5 sec.	4.5 sec.
<b>COOLANT FACILITIES</b>		
Coolant Capacity	31.7 Gallons (120L)	95 Gallons (360L)
<b>ACCURACY SPECIFICATIONS (ISO - 230-2)</b>		
Positioning	0.0004" (0.01mm)	0.0005" (0.01mm)
Repeatability	0.0002" (0.005mm)	0.003" (0.003mm)
<b>MISCELLANEOUS</b>		
Power Supply Requirement	6/FLA	9/FLA
Electrical Supply	50 or 60 Hz	50 or 60 Hz
Voltage	220	208-230 or 380-440
Compressed Air Requirement	70 psi (5kg/cm <sup>2</sup> )	70 psi (5kg/cm <sup>2</sup> )
<b>MACHINE DIMENSIONS</b>		
Length	80.12" (2,035mm)	129.89" (3,298mm)
Depth	83.35" (2,168mm)	108.43" (2,754mm)
Height	82.20" (2,088mm)	113.31" (2,878mm)
Approx. Weight	6,400lbs (290kg)	20,680lbs (940kg)

# SPECIFICATIONS

	GX 1600	GX 1300-50/1600-50
<b>AXIS TRAVEL</b>		
X-Axis	62.99" (1600mm)	1300: 51" (1295mm) 1600: 62.99" (1600mm)
Y-Axis	27.55" (700mm)	27.55" (700mm)
Z-Axis	25" (635mm)	25" (635mm)
Table surface to spindle gauge distance	5.24"-30.24" (133-768mm)	5.24"-30.24" (133-768mm)
<b>POSITIONING</b>		
Auto-Mode (X,Y,Z Axes)	36m/min (1,1417ipm)	36m/min (1,1417ipm)
Feedrate Range (X,Y,Z Axes)	0.0025-12m/min (0.1-472ipm)	0.0025-12m/min (0.1-472ipm)
Minimum Increment	0.0004" (0.001mm)	0.0004" (0.001mm)
Ball Screw Diameter and Pitch (X & Y Axes)	1.57" x 0.472" (40 x 12mm)	1.77" x 0.472" (45 x 12mm)
<b>SPINDLE</b>		
Speed Belted	10,000RPM	10,000RPM
Motor Power Rating - CT/30/15/1min.	15/20/24.8HP (11/15/26kW)	29.8/34.8/46.9HP (22/26/35kW)
Torque (S3-60%)	104ft/lbs (141Nm)	160ft/lbs (216Nm)
Retention Force	7.8295N (1.760lbf)	-
Spindle Taper	No. 40, BIG PLUS®	No. 50, BIG PLUS®
Tool Holder	CT40 or BT40	CT50 or BT50
<b>WORKTABLE</b>		
Working Surface	27.55" x 66.93" (700 x 700mm)	56/66.93" x 27.55" (1425/1700 x 700mm)
Table Load	3,300lbs (1500kg)	3,300lbs (1500kg)
Number of T-Slots	5	5
T-Slot Size	0.708" (18mm)	0.708" (18mm)
T-Slot Center Dimension	4.92" (125mm)	4.92" (125mm)
<b>CONTROL</b>		
FANUC	0iMD	0iMD
<b>AUTOMATIC TOOL CHANGER - Swing Arm</b>		
Magazine Capacity	30 Tools (40 Opt)	24 Tools (32 Opt)
Tool Select by Shortest Path & Random Select	Bi-Directional	Bi-Directional
Max Tool Diameter (Full Drum)	3" (76.2mm)	4.29" (109mm)
Max Tool Diameter (Adjacent Pockets Empty)	5.9" (150mm)	7.87" (200mm)
Max Tool Length	13.7" (350mm)	13.70" (350mm)
Max Tool Weight	17.6lbs (8kg)	33.7lbs (15kg)
Random Tool Change Time (tool to tool/c to c)	4.5 sec.	5.8 sec.
<b>COOLANT FACILITIES</b>		
Coolant Capacity	131 Gallons (500L)	131 Gallons (500L)
<b>ACCURACY SPECIFICATIONS (ISO - 230-2)</b>		
Positioning	0.014" (0.005mm)	0.0005" (0.014mm)
Repeatability	0.0003" (0.007mm)	0.0003" (0.007mm)
<b>MISCELLANEOUS</b>		
Power Supply Requirement	92FLA	109FLA
Electrical Supply	50 or 60 Hz	50 or 60 Hz
Voltage	208-230 or 380-440	208-230 or 380-440
Compressed Air Requirement	70 psi (5kg/cm <sup>2</sup> )	70 psi (5kg/cm <sup>2</sup> )
<b>MACHINE DIMENSIONS</b>		
Length	153.46" (3898mm)	107/153.46" (3,298/3898mm)
Depth	108.43" (2,754mm)	108.43" (2,754mm)
Height	113.31" (2,878mm)	113.31" (2,878mm)
Approx. Weight	21,560lbs (9800kg)	21,560lbs (9800kg)



## HARDINGE COMPANIES WORLDWIDE

Hardinge is a leading international provider of advanced metal-cutting solutions. We provide a full spectrum of highly reliable CNC turning, milling, and grinding machines as well as technologically advanced workholding accessories.

The diverse products we offer enable us to support a variety of market applications in industries including aerospace, agricultural, automotive, construction, consumer products, defense, energy, medical, technology, transportation and more.

We've developed a strong global presence with manufacturing operations in North America, Europe, and Asia. Hardinge applies its engineering and applications expertise to provide your company with the right machine tool solution and support every time.

### AMERICAS

*Pennsylvania*  
Hardinge Corporate  
1235 Westlakes Drive  
Suite 410  
Berwyn, PA 19312

*New York*  
Hardinge  
One Hardinge Drive  
Elmira, NY 14903  
P.800.843-8801  
E.info@hardinge.com  
www.hardinge.com

*Illinois*  
Hardinge  
1524 Davis Road  
Egin, IL 60123  
P.800.843.8801

### ASIA

*China*  
Hardinge Machine  
(Shanghai) Co. Ltd.  
1388 East Kangqiao Road  
Rudong, Shanghai 201319  
P.0086 21 3810 8686

*Taiwan*  
Hardinge Taiwan Precision  
Machinery Limited  
4 Tzu Chiang 3rd Road  
Nan Tou City 340  
Taiwan  
P.886 49 2260 536  
E.cs@hardinge.com.tw

### EUROPE

*France*  
Jones & Shipman SARL  
8 Allée des Ginkgos  
BP 112-69672  
Bron Cedex, France

*Germany*  
Hardinge GmbH  
Fichtenhain A 13c  
47807 Krefeld  
P.49 2151 49649 10  
E.info@hardinge-gmbh.de

*Switzerland*  
L. Kellenberger & Co. AG  
Heiligkreuzstrasse 28  
CH 9008 St. Gallen  
Switzerland  
P.41 71 2429111  
E.info@kellenberger.net

*United Kingdom*  
Jones & Shipman  
Hardinge Ltd.  
Munray Field Road  
Leicester LE3 1UW  
P.44 116 201 3000  
E.info@jonesshipman.com



800-843-8801 • info@hardinge.com • parts@hardinge.com • service@hardinge.com  
WWW.HARDINGE.COM • WWW.SHOPHARDINGE.COM

All prices and specifications are subject to change without notice. All marks indicated by ® and ™ are trademarks of their respective owners. #13531  
© Hardinge Inc. • 03/10