



CHEMICAL PUMP & FILTER  
WITH ACID-ALKALI RESISTANCE  
EXPERT IN R&D AND MANUFACTURING

# Magnetic Pump

Model : QHX

Guangdong Qihua Industry Equipment Co.,Ltd



# Workshop & Warehouse





## Magnetic pump [QHX series]

### Product characteristics

1. The magnetic pump adopts the non-shaft-seal design, and the pump is completely sealed without leakage;
2. Equipped with anti idling device, so that the magnetic pump will not be damaged in case of no water idling for a long time, and improve the durability of the product;
3. The new design of flow passage can minimize the loss of products and improve the use efficiency
- 4 The applicable temperature shall be determined according to different chemical properties: GFRPP - below 80 °C, CFRPP - below 80 °C, PVDF - below 100 °C, CFRETFE - below 150 °C.

### Product superiority

1. A variety of connection modes of front cover inlet and outlet are available;
2. The front and rear covers adopt convex point structure and flat gasket sealing ring to ensure excellent sealing effect;
3. Impeller deflection is lower than 0.2mm;
4. Passive magnets and plastic shells are injection molded at one time to ensure that there is no penetration forever.
5. The shaft core is made of 88% alumina and SSIC material;
6. The gasket of the back cover is made of SUS304 material to enhance its temperature resistance and pressure resistance;
7. The connection between the motor and the pump head is a plastic injection molding integrated structure, which can prevent the corrosion of the connection caused by the leakage of acid and alkali gas and liquid;
8. The surface of drive magnet adopts resin paint baking, with better corrosion resistance. After dynamic balance test, the vibration of drive magnet is lower than 2.0mm/s;
9. The motor adopts international brand, with stable performance and ultra-quiet operation.

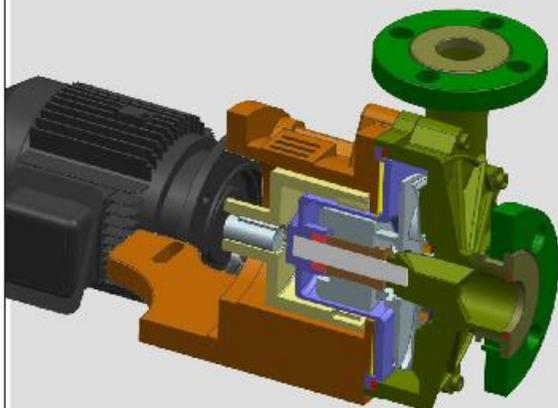

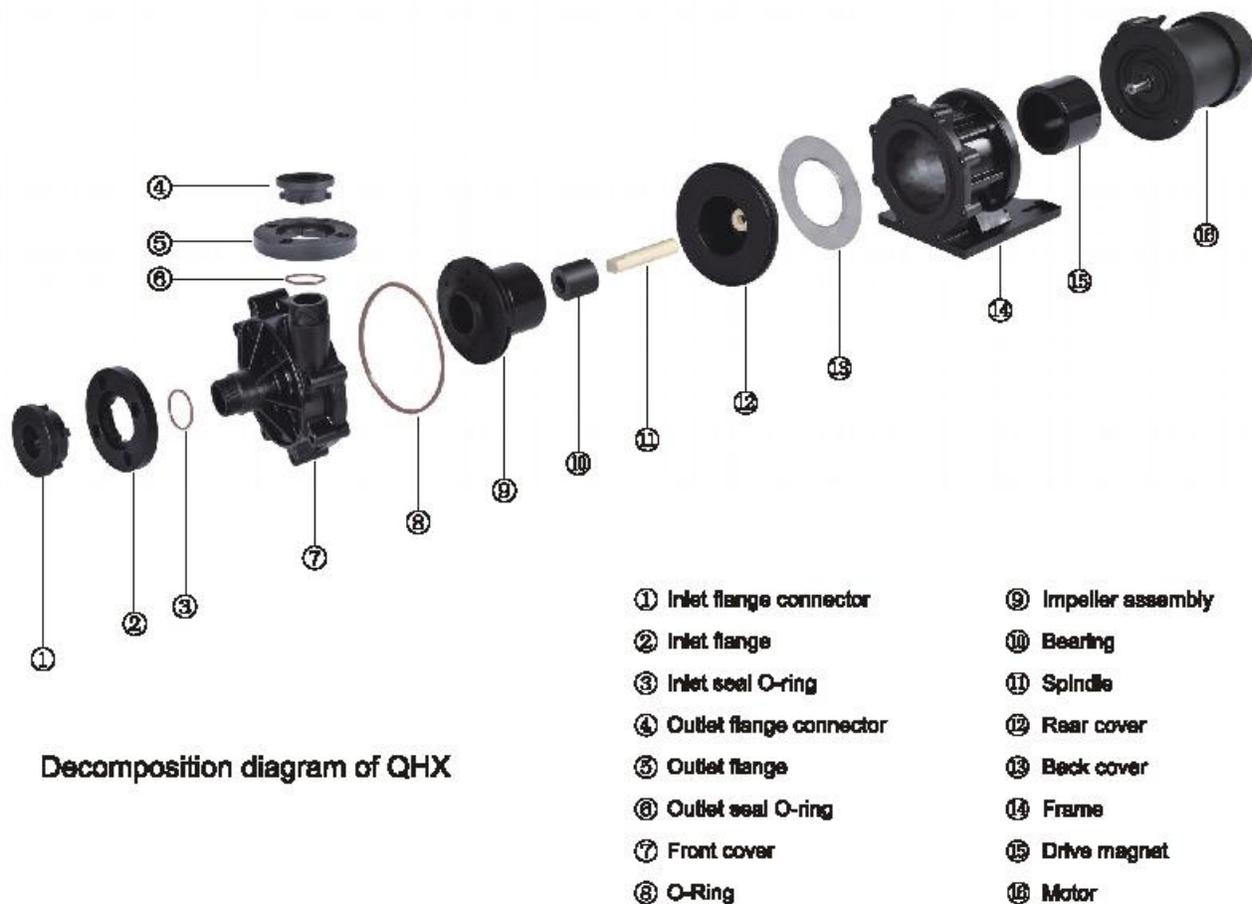

## Model description

**QHX--F--54--3--C--C--V--5--V38--A**

① ② ③ ④ ⑤ ⑥ ⑦ ⑧ ⑨ ⑩

- ① Model No.: QHX
- ② Pump material: F-GFRPP; C-CFRPP; P-PVDF; E-CFRETPE
- ③ Inlet and outlet diameter: 25-25x25mm; 44-40x40mm; 54- 50x40mm; 65-65x50mm; 66-65x65mm;
- ④ Horsepower:0-1/2HP; 1-1HP; 2-2HP; 3-3HP; 5-5HP
- ⑤ Pump shaft material: C-ceramic; S-SSIC
- ⑥ Bearing material: C- graphite; S- SSIC; P- PTFE
- ⑦ O-Ring: E-EP DM; V-VTTO N(FKM)
- ⑧ Frequency: 5-50HZ; 6- 60HZ
- ⑨ Voltage: V38-30/220V/380V; V41-30/280V/415V; V44-30/240V/440V
- ⑩ Specific gravity of liquid medicine: 50HZ- -A-1.2 / B-1.5 / C-2.0; 60HZ- -A-1.2 / B-1.5 / C-2.0

## Product specification

Model	Inlet and outlet diameter (mm)	Max.Head(m)		Max.Capacity(L/min)		Power(HP)	Weight ( kg )
		50Hz	60Hz	50Hz	60Hz		
QHX-250	25/25	16.12	15.33	150	150	0.5	14.5
QHX-440	40/40	12.3	13.0	240	240	0.5	13.3
QHX-251	25/25	22.09	23.46	180	180	1	19.1
QHX-441	40/40	19.0	19.6	330	330	1	19.0
QHX-542	50/40	24.4	25.3	450	450	2	25.7
QHX-552	50/50						26.5
QHX-542H	50/40	27.6	30.6	250	150	2	25.7
QHX-552H	50/50						26.5
QHX-543	50/40	30.6	31.8	510	510	3	27.9
QHX-553	50/50						28.0
QHX-543H	50/40	34.2	36.6	300	250	3	27.9
QHX-553H	50/50						28.0
QHX-545	50/40	35.0	39.4	500	500	5	38.6
QHX-555	50/50						34.4
QHX-653	65/50	20.0	20.1	600	600	3	29.6
QHX-655	65/50	27.6	28.1	860	860	5	39
QHX-662	65/65	14	15	900	850	2	27.7
QHX-663	65/65	17	18	1050	1000	3	29.2
QHX-665	65/65	21	23	1230	1250	5	39.2

## Size specification

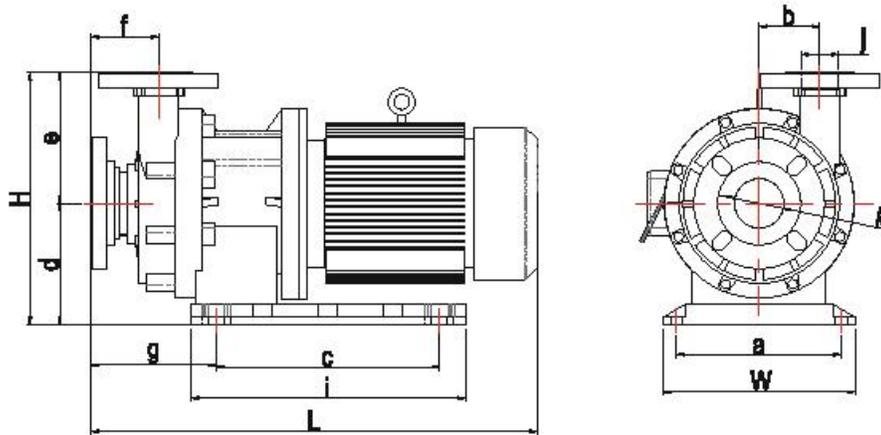

Model	L	H	W	a	b	c	d	e	f	g	i	j	k
QHX-250	453	261	191	146	65	132	119	142	88	170	207	Ø20	Ø20
QHX-440	453	229	157	130	54	130	97	132	87.5	136	200	Ø36.5	Ø36.5
QHX-251	468	254	191	127	65	131	114	140	90	161	207	Ø20	Ø20
QHX-441	482	257	194	127	72	135	110	147	105	177	219	Ø36.5	Ø36.5
QHX-542	536	286	261	207.5	80	200	120.5	165.5	96.5	160	275	Ø36.5	Ø44.0
QHX-552	534	283	261	207.5	80	200	120.5	162.5	95	160	275	Ø44.0	Ø44.0
QHX-542H	536	286	261	207.5	80	200	120.5	165.5	96.5	160	275	Ø36.5	Ø44.0
QHX-552H	534	283	261	207.5	80	200	120.5	162.5	95	160	275	Ø44.0	Ø44.0
QHX-543	536	286	261	207.5	80	200	120.5	165.5	96.5	160	275	Ø36.5	Ø44.0
QHX-553	533	283	261	207.5	80	200	120.5	162.5	93	159	275	Ø44.0	Ø44.0
QHX-543H	536	286	261	207.5	80	200	120.5	165.5	96.5	160	275	Ø36.5	Ø44.0
QHX-553H	533	283	261	207.5	80	200	120.5	162.5	93	159	275	Ø44.0	Ø44.0
QHX-545	593	325	250	216	80	295	158	167	96	152	362	Ø36.5	Ø44.0
QHX-555	594	323	263	217	80	296	157	166	96	160	355	Ø44.0	Ø44.0
QHX-653	524	333	250	216	80	295	158	175	82	147	363	Ø44.0	Ø65.5
QHX-655	590	333	250	216	80	295	158	175	89	159	363	Ø44.0	Ø65.5
QHX-662	555	288	261	206	80	200	118	170	96	177	274	Ø65.5	Ø65.5
QHX-663	555	288	261	206	80	200	118	170	96	177	274	Ø65.5	Ø65.5
QHX-665	610	333	250	216	80	295	158	175	98	168	360	Ø65.5	Ø65.5

## Installation diagram

Used in heat exchanger

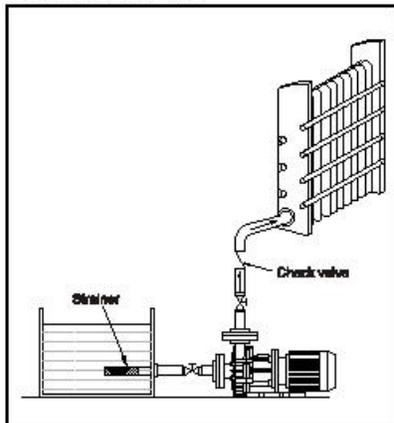

Used in reaction tank or filter compressor

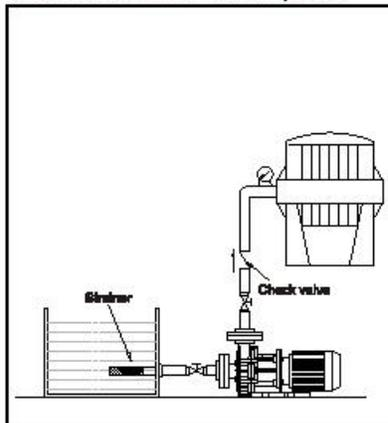

Used in waste gas cleaning tower

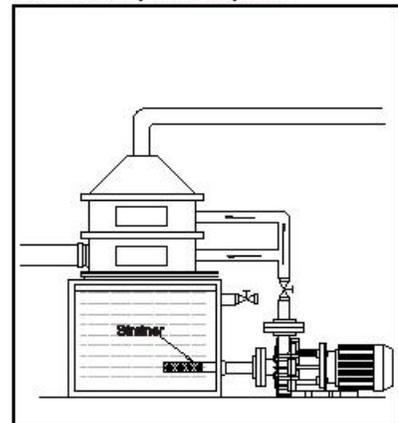

Warning: incorrect use

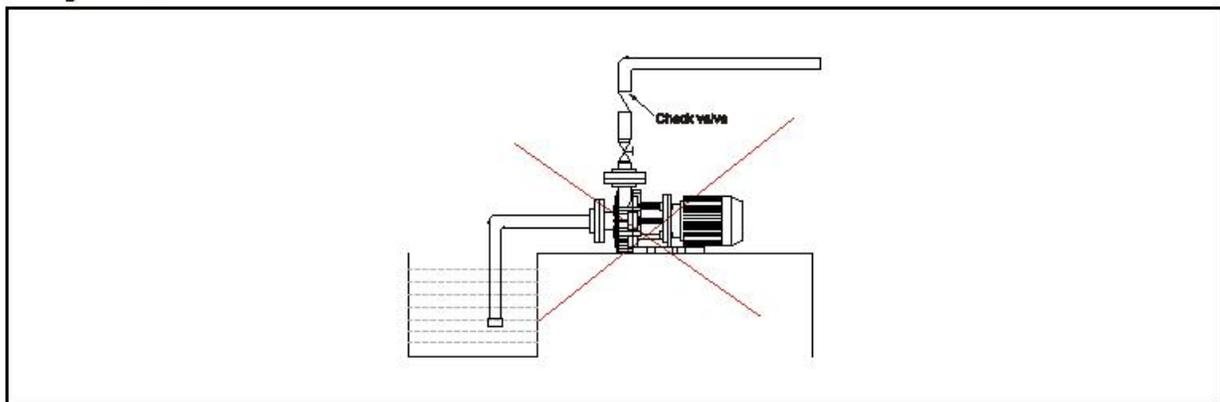

## Precautions for safe operation

### 1. Safety warning!

- ① Running without cutting off the power will cause electric shock!
- ② Do not start the pump without connecting the ground wire and leakage protector!
- ③ Electrician operation should be carried out by professional personnel!
- ④ When operating the pump, please wear protective equipment to prevent serious injury caused by chemical solution!
- ⑤ Operations related to toxic liquids may cause poisoning!
- ⑥ Use the pump in strict accordance with the instructions and scope of use!
- ⑦ During operation, the surface temperature of motor and pump is very high, do not touch directly!
- ⑧ It is forbidden to transform the pump without permission, otherwise serious accidents will be caused. If the pump is modified without permission or in accordance with the operating instructions, the company will not bear any loss caused by the user!
- ⑨ There is a strong magnet in the magnetic drive pump. Its strong magnetic field will cause obvious damage to the person wearing the electronic device (i.e. electronic pacemaker, etc.)!

### 2. Important note!

- ① No idling of the pump. The idling of the pump can make the parts inside the pump heat up by friction, which will damage the pump. Pump operation with suction valve fully closed is also considered as idling.
- ② In the process of operation, when dangerous signals and abnormal conditions are found, the operation shall be terminated immediately, and it shall be started after the exception is eliminated.
- ③ The operation and use of the pump must be carried out by qualified operators.
- ④ The pump is only allowed to be used under the specified voltage, otherwise the pump will be damaged or fire will be caused.
- ⑤ The use place of the pump shall be equipped with protective measures to prevent liquid splashing or leakage.
- ⑥ Operations related to toxic liquids may cause poisoning, so it is necessary to ensure adequate ventilation at the operation site.
- ⑦ Do not scrape, damage, squeeze or stretch the cable with force. The use of damaged cables is likely to cause fire or electric shock.
- ⑧ The covered pump is easy to cause fire or mechanical failure due to internal heat accumulation during operation.
- ⑨ When a pump is under maintenance, pay attention to avoid other operators turning on the power supply switch due to mistakes. It is better to place a warning sign beside the power supply switch to inform that the pump is under maintenance.
- ⑩ The liquid from the pump may be highly toxic and harmful chemicals, which must be drained to a special container for storage.

## QHX-440 Performance curve

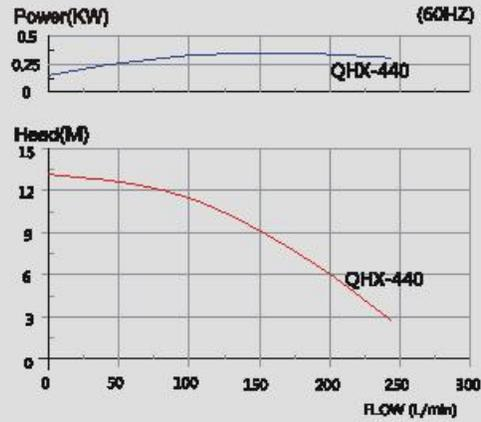
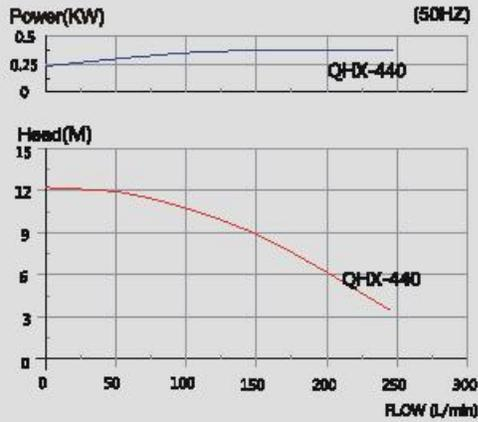

## QHX-441 Performance curve

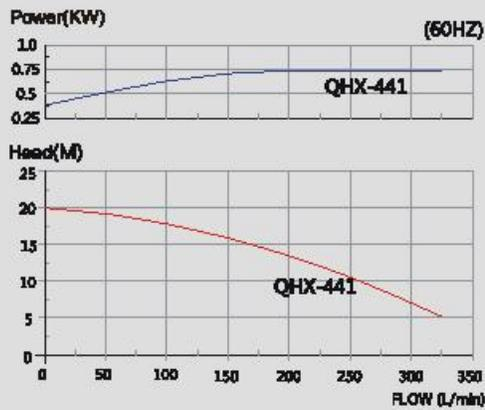
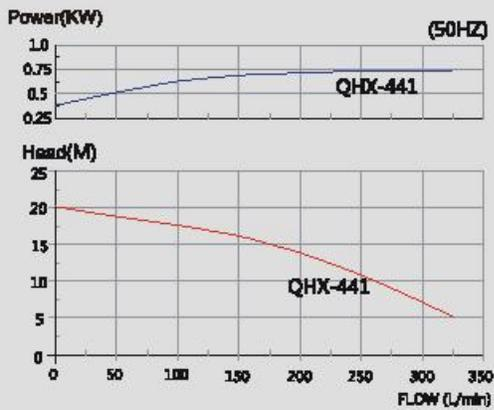

## QHX-542H(552H) Performance curve

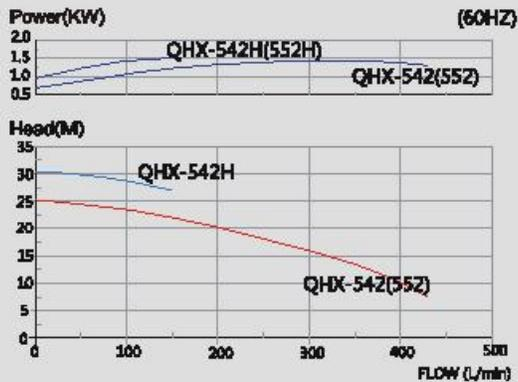
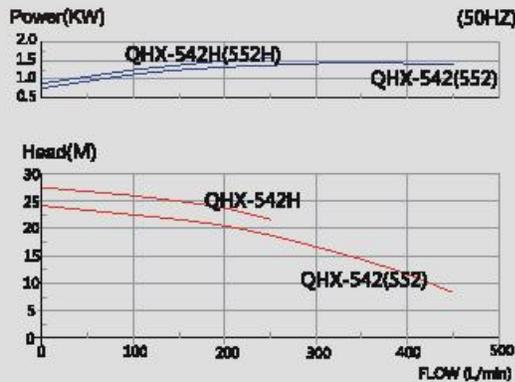

## QHX-543H(553H) Performance curve

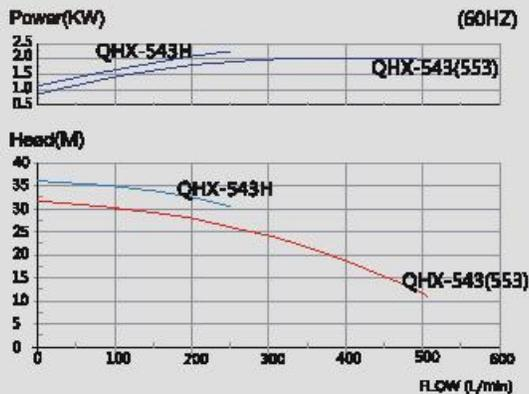
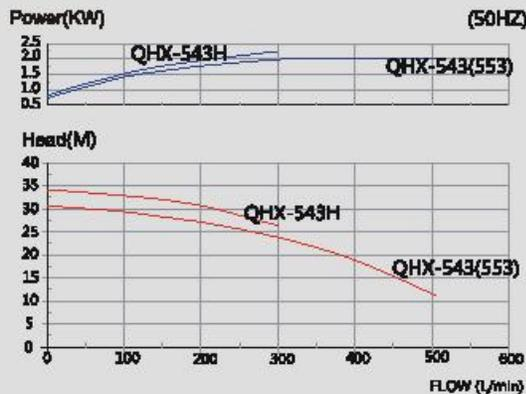

## QHX-555(545) Performance curve

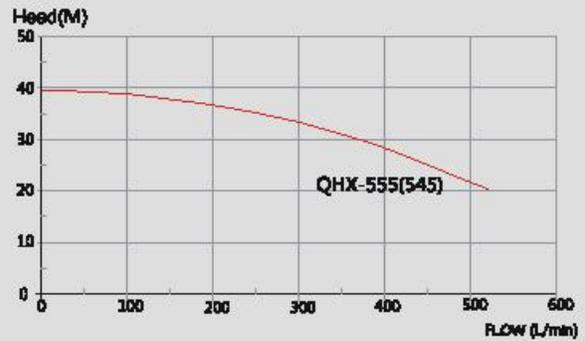
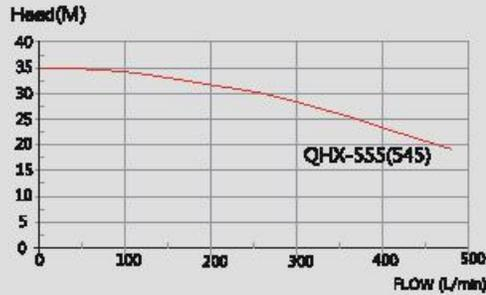
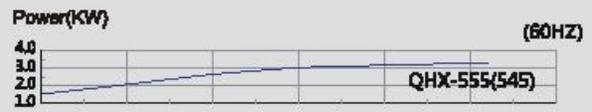

## QHX-655/653 Performance curve

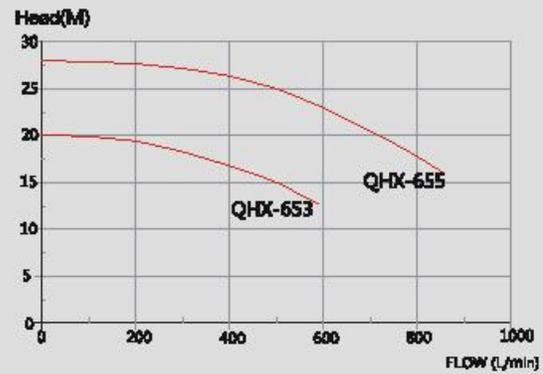
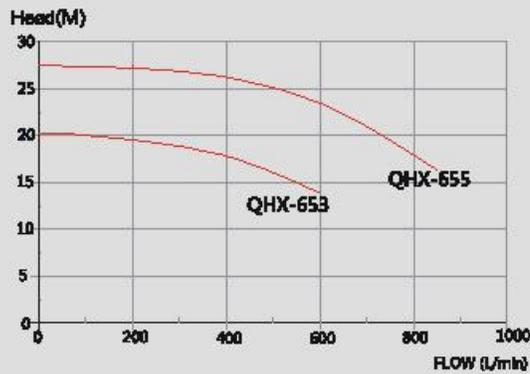
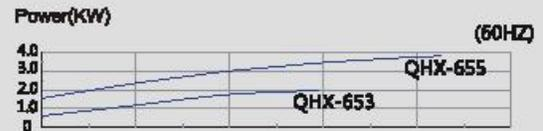
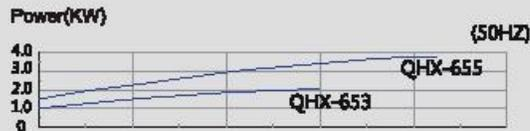

## QHX-250/251 Performance curve

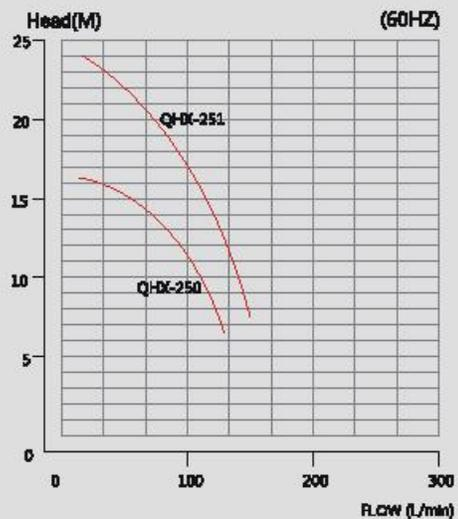
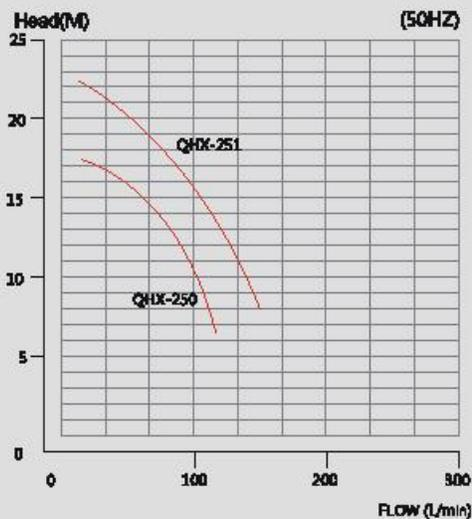

## QHX-662 Performance curve

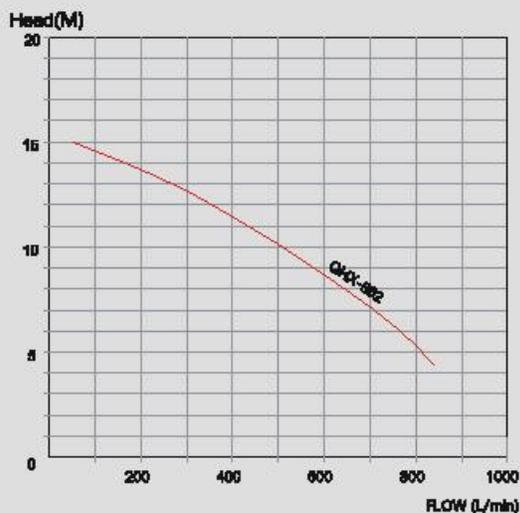
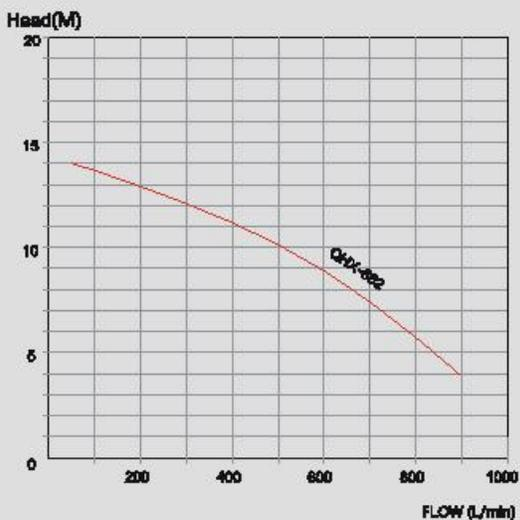
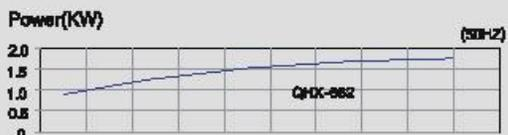

## QHX-663 Performance curve

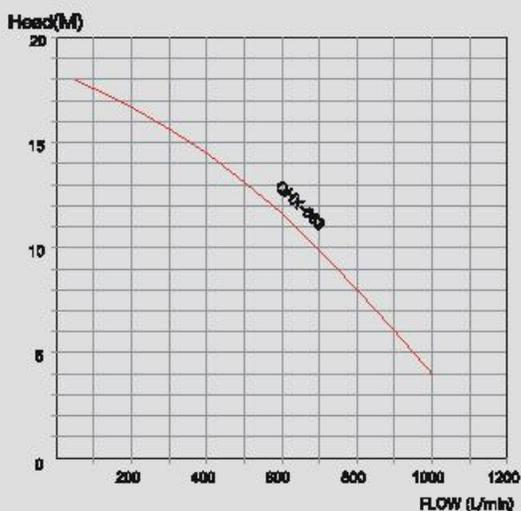
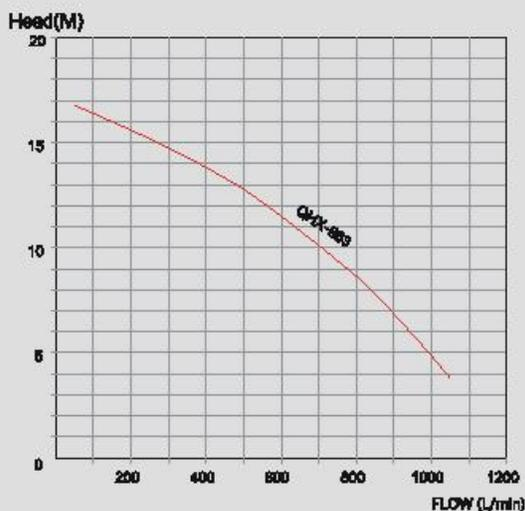
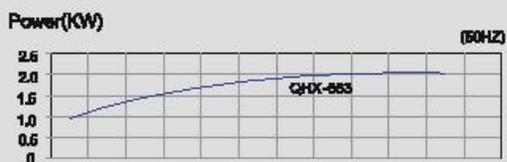

# QHX-665 Performance curve

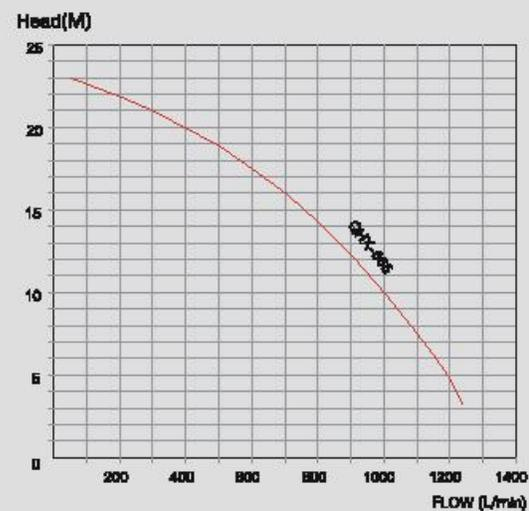
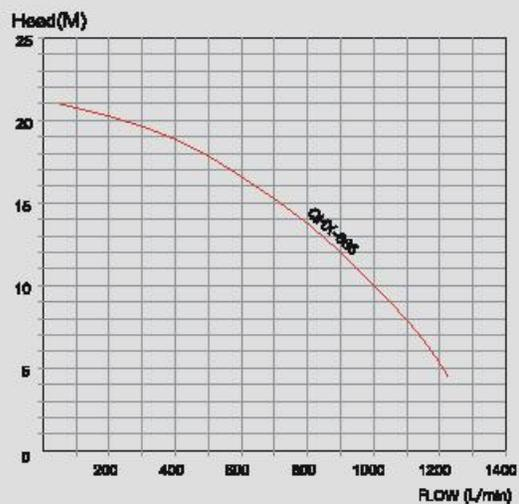
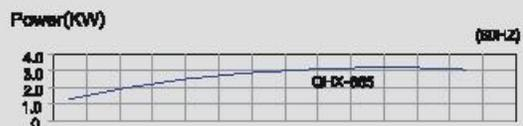
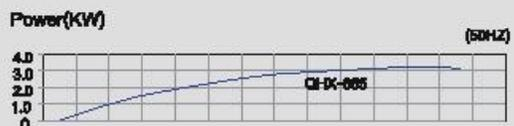

## 1. High cost performance:

Independent production, stable quality and controllable cost.

## 2. Excellent product performance:

Corrosion resistance, idling resistance, no leakage, low noise, high efficiency, surface corrosion resistance, durable.

## 3. Advanced product technology:

Cooperate with colleges and universities to carry out production, learning and research activities, master cutting-edge technology, and constantly make breakthroughs in the direction of low energy consumption and high efficiency. At present, the unique technology includes: 4P motor magnetic pump addresses the problem of rapid temperature rise of liquid medicine, and intelligent monitoring addresses the problem of idling.

## 4. Continuous upgrading of materials:

Imported CFRETFE material is resistant to strong acid, strong alkali and high temperature.

## 5. Rich product categories:

It can be upgraded to replace all kinds of old equipment.

## 6. Three to five year extended warranty:

Make customers free from worry and labor cost.

## 7. Professional and efficient service:

Before sales, a strong technical team can help customers select models accurately and reduce waste; after sales, tailor training programs for customers to reduce human losses; 4-hour quick response and efficient service!

## 8. Strong qualification:

Patented technology, CE, SGS quality certification of European Union, government designated supplier

## 9. Flexible cooperation mode:

Welcome OEM customization and regional agents.

## 10. Unique family culture:

Stable and happy team, long-term and reliable cooperation.

**Why  
choose  
Qihua?**



The enterprise has been engaged in independent research and development since 2012. At present, it has possessed ten utility model patents, one appearance patent and two CE certificates. In addition, it is applying for three utility model patents and two invention patents, and plans to apply for more than 20 kinds of patents.



### PART OF OUR SUPPLIERS

Your contribution is indispensable to the high quality products of Qeehua



### PART OF OUR CUSTOMERS

Think what the customer thinks, and be grateful to every customer



### Head office in South China

Guangdong Qihua Industry Equipment Co., Ltd  
 No. 8, Chenwu East Road, Houjie Town, Dongguan City, Guangdong Province  
 Tel: +86 400-8558-745 +86 789 8558 7455 Fax: +86 789-8558 6455  
 Chinese website: <https://www.qeehua-pump.com> English website: <https://www.qeehuapup.com> Vietnamese website: <https://www.qeehua.com>