



TIANHE Oil Group is an integrated corporation engaged in petroleum equipment design, manufacture, sale, rental, and maintenance, oil engineering services and oilfield exploration and development.

TIANHE Oil Group has 5 business scopes throughout 50 countries and regions as follows:

#### **1. Drilling Tools Scope :**

The first scope supports the design, manufacture, sale, rental and maintenance of drilling tools such as drill pipe, heavy weight drill pipe, drill collar, kelly, stabilizers, downhole motors, jars, **absorber**, fishing tools, milling tools and valves etc.

#### **2. Rigs and Offshore Services Scope :**

This division supports the design, manufacture, sale, rental, maintenance and other engineering services for skid-mounted rigs, mobile drilling rigs, workover rigs, offshore drilling platforms and platform cranes etc.

#### **3. Oilfield Engineering Services Scope:**

This division provides an integrated oilfield engineering support for drilling engineering services, downhole operation services, logging services, directional drilling services, cooperative cementing services and cooperative well completion services etc.

#### **4. Oilfield Exploration and Development Scope :**

This scope sources, acquires and manages oilfield exploration and development projects, via wholly owned, joint ventures or profit sharing company.

#### **5. Processing Trade with Provided Materials Scope:**

Taking advantage of geographical logistics of Shanghai Free Trade Zone and Yangshan Port, Shanghai TIANHE undertakes processing on giving materials or samples, seeking the common development of diversified forms such as cooperation or joint venture, both domestically and internationally.

Over the years, TIANHE Oil Group, regarding “people-oriented, technology first, continuous improvement, casting brand” as our management guidance, continuously strives to innovate and improve our products and expand business related to oilfield. Meanwhile, The company also increases investment in technology research and development, always takes providing the global customers with the best technical products and services as our company’s mission.

TIANHE Oil Group strongly believes and promotes Total Quality Management, implement the ISO quality management system and HSE management system and API Standard, which has been deeply implanted into every person’s thought and carried out into every aspect of work.

Our manufacturing facilities are well equipped with four automated induction heat treatment lines and dozens of other types of heat treatment ovens and well furnaces to ensure full coverage of heat treatment requirements by different products to achieve the required mechanical properties.

In order to ensure the quality consistency and interchangeability of high precision components, TIANHE has introduced WFL 5-axis Linkage Turning & Milling Machining Center from Austria, Mazak’s turn milling machining center from Japan and the Haas horizontal machining center from USA. These processes are facilitated with precise quality inspection equipment such as the Brunner OES Metal Analyzers from Germany, Ultrasonic and Magnetic Powder Flaw Detector and high precision Hexagon Three Coordinate Measuring Machine and Farco Portable Three Coordinate Measuring Machine.

So far, TIANHE Oil Group has established strong business relationships with over 200 international oil & gas companies in supporting the top 50 oil producing countries.



Rotary Kelly.....	04	DJ Surface Bumper Jar.....	45
Drill Pipe.....	05	KXJ Fishing Bumper Sub.....	46
Tool Joint.....	06	BXJ Lubricated Fishing Bumper Sub.....	47
Tool Joint.....	07	SJ Double-way Shock Absorber.....	48
Drill Collar-Standard And Spiral.....	08	YJ One-way Shock Absorber.....	49
Special Features For Drill Collar.....	09	Series 150 Overshot.....	50
Non-Magnetic Drill Collar .....	10	Series 150 Overshot Accessories.....	51
Heavy Weight Drill Pipe.....	11	Series 70 Short Catch Overshot.....	52
Downhole Motor.....	12	Series 10 And 20 Overshot.....	53
Integral Blade Stabilizer.....	13	DLT-T Releasing And Reversing Overshot.....	54
Integral Spiral Blade Stabilizer.....	14	Lifting-lowering And Releasing Overshot.....	55
Integral Spiral Blade Stabilizer.....	15	Releasing Spear.....	56
Integral Spiral Blade Stabilizer.....	16	Releasing Spear Accessories.....	57
Non-rotating Stabilizer.....	17	Releasing Sub.....	58
Replaceable Sleeve Stabilizer.....	18	Releasing Spear.....	59
Hardfacing Types Of Stabilizer .....	19	Cable Fishing Hook& Sliding Block Spear.....	60
Fixed Diameter Hole Opener .....	20	Taper Tap.....	61
Roller Reamer.....	21	Die Collar.....	62
Casing Scraper.....	22	Internal Hook & External Hook .....	63
Key Seat Wiper.....	23	Reversing Circulation Junk Basket.....	64
Rotary Sub And Others.....	24	Standard Fishing Magnet.....	65
Oriented Bent Sub.....	25	Reverse Circulation Fishing Magnet.....	66
Circulating Sub.....	26	Ditch Magnet.....	67
Wear Sub.....	27	Junk Mill.....	68
Drift.....	28	Junk Sub.....	69
Lifting Cap & Casing Protector.....	29	Washover Pipe.....	70
Kelly Valves.....	30	Washover Pipe Accessories.....	71
Full Opening Safety Valve.....	31	Mechanical Internal Cutter.....	72
Drop-in Check Valve.....	32	Mechanical External Cutter.....	73
Inside BOP.....	33	Multi-string Cutter.....	74
Arrow Type Back Pressure Valve.....	34	Section Mill.....	75
Float Valve Sub.....	35	Type H Safety Joint & Type AJ Safety Joint.....	76
By-Pass Valve.....	36	Impression Block.....	77
Cup Tester.....	37	CZJ-I Hydraulic Bucking Unit.....	78
QJZ Mechanical Drilling Jar.....	38	Open Type Quick-rotary Hydraulic Bucking Unit.....	79
JYSJ Double Acting Hydraulic-mechanical Drilling Jar.....	39	KCZ J400 Flip Type & CZPT-II .....	80
QYSZ DOUBLE Acting Hydraulic Drilling Jar.....	40	CZJQZ-II Type 360° Rotation Hydraulic Bucking Unit .....	81
ZSJ/ZXJ Hydraulic & Mechanical Two-piece Drilling Jar.....	41	LMST- II Down-hole MOTOR TESTER & SYJ Hydraulic Jar Tester.....	82
YSJ Type z Oil Jar.....	42	DYNJ—200/20 Type Hydraulic Screwing Machine.....	83
CSJ Supper Fishing Jar.....	43	SXL AUTOMATIC Loading And Uploading Machine.....	83
ZJS Jar Intensifier.....	44	HIGH TORQUE DOUBLE SHOULDER THREADED Connection.....	84
		Quality Examination.....	85

Kelly is main driver of the whole drill string. It transmits torsional energy from the rotary table through the drill string to the bit at the bottom of the hole. TIANHE Kelly is a long square or hexagonal, precision machined heavy steel bar that is supported by the swivel through the rotary table and is connected to the first joint of drill pipe in the drill string.

Straightness of the kelly is very crucial in the manufacturing process, thus straightness inspections are carried out before, during and after each machining operation. The flats are precision-milled to API specifications. All milling processes are performed on specially designed rigid Kelly mills to ensure tight tolerances and high quality drive sections. Each TIANHE Kelly is furnished with a pressed steel thread protectors.

### Features and Benefits

- Manufactured from AISI 4145H-modified, fully heat-treated alloy steel with a Brinell hardness range of 285-341BHN and a minimum average Charpy impact value of 40 ft-lbs;
- Ends and drive sections, IDs and connections machined and inspected to API specifications;
- Ultrasonic inspection is performed on all sections;
- Shipped in a protective steel-cased scabbard;

### When ordering please specify:

- Kelly type (square or hexagonal);
- nominal size and overall length;
- Upper and lower connections.

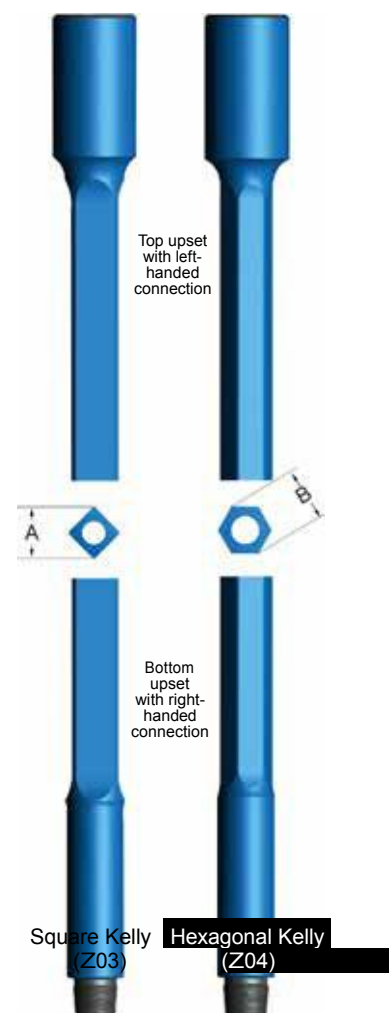

### Specifications - Rotary Kelly

Nom Size (in)	Square Kelly Product Code	Hexagonal Kelly Product Code	Top Connection(LH)		Bottom Connection		I.D.(in)		Drive Section(in)	
			Standard O.D.(in)	Optional O.D.(in)	Square O.D.(in)	Hex. O.D.(in)	Square	Hex.	A	B
2 1/2	Z03-130000		6 5/8 REG LH 7 3/4	4 1/2 REG LH 5 3/4	NC26 3 3/8		1 1/4		3 1/4	
3	Z03-130100	Z04-130000	6 5/8 REG LH 7 3/4	4 1/2 REG LH 5 3/4	NC31 4 1/8	NC26 3 3/8	1 3/4	1 1/4	3 3/8	3 3/8
3 1/2	Z03-130200	Z04-130100	6 5/8 REG LH 7 3/4	4 1/2 REG LH 5 3/4	NC38 4 3/4	NC31 4 1/8	2 1/4	1 3/4	4 7/16	3 15/16
4 1/4	Z03-130300	Z04-130200	6 5/8 REG LH 7 3/4	4 1/2 REG LH 5 3/4	NC46 6 1/4	NC38 4 3/4	2 13/16	2 1/4	5 1/2	4 25/32
	Z03-130400	Z04-130300	6 5/8 REG LH 7 3/4	4 1/2 REG LH 5 3/4	NC50 6 3/8	NC38 4 3/4	2 13/16	2 1/4	5 1/2	4 25/32
5 1/4	Z03-130500	Z04-130400	6 5/8 REG LH 7 3/4		5 1/2 FH 7	NC46 6 1/4	3 1/4	3	6 3/4	5 29/32
	Z03-130600	Z04-130500	6 5/8 REG LH 7 3/4		NC56 7	NC50 6 3/8	3 1/4	3 1/4	6 3/4	5 29/32
6		Z04-130600	6 5/8 REG LH 7 3/4			5 1/2 FH 7		3 1/2		6 13/16
		Z04-130700	6 5/8 REG LH 7 3/4			NC56 7		3 1/2		6 13/16





TIANHE provides a complete line of drill string products, including a full range of friction welded drill pipes in nominal sizes from 2-3/8" to 6-5/8" and in a wide range of wall thicknesses. TIANHE drill pipe adopts a strict quality control regimen to ensure total quality control from initial material qualification, in-process inspection to final outgoing quality inspection. We ensure that each joint of drill pipe meets your needs for reliability, durability and performance.

Specification a						OD of pipe	Wall thickness	Dia. of welded neck	Tool joint					
Model	Product code	Weight lb/ft	Grade	Upset form	Conn				Ddp mm	t mm	mm	OD	ID of pin thread	Length of pin thread
						-12.50%	Max	mm		mm	mm	mm	mm	mm
2 3/8	Z09-01000	6.65	E	EU	NC26	60.32	7.11	65.1	85.7	44.5	177.8	203.2	82.95	10.45
2 3/8	Z09-01000	6.65	X, G	EU	NC26	60.32	7.11	65.1	85.7	44.5	177.8	203.2	82.95	10.58
2 7/8	Z09-02000	10.4	E	EU	NC31	73.02	9.19	81	104.8	54	177.8	228.6	100.41	16.25
2 7/8	Z09-02000	10.4	X, G	EU	NC31	73.02	9.19	81	104.8	50.8	177.8	228.6	100.41	16.5
2 7/8	Z09-02000	10.4	S	EU	NC31	73.02	9.19	81	111.1	41.3	177.8	228.6	100.41	17.19
3 1/2	Z09-03000	9.5	E	EU	NC38	88.9	6.45	98.4	120.7	68.3	203.2	266.7	116.28	15.77
3 1/2	Z09-03001	13.3	E	EU	NC38	88.9	9.35	98.4	120.7	68.3	203.2	266.7	116.28	20.77
3 1/2	Z09-03001	13.3	X	EU	NC38	88.9	9.35	98.4	127	65.1	203.2	266.7	116.28	21.76
3 1/2	Z09-03001	13.3	G	EU	NC38	88.9	9.35	98.4	127	61.9	203.2	266.7	116.28	21.9
3 1/2	Z09-03001	13.3	S	EU	NC38	88.9	9.35	98.4	127	54	203.2	266.7	116.28	22.22
3 1/2	Z09-03002	15.5	E	EU	NC38	88.9	11.4	98.4	127	65.1	203.2	266.7	116.28	24.67
3 1/2	Z09-03003	15.5	X	EU	NC38	88.9	11.4	98.4	127	61.9	203.2	266.7	116.28	25.07
3 1/2	Z09-03003	15.5	G	EU	NC38	88.9	11.4	98.4	127	54	203.2	266.7	116.28	25.38
3 1/2	Z09-03003	15.5	S	EU	NC40	88.9	11.4	98.4	139.7	57.2	203.2	266.7	127.4	26.19
4	Z09-04000	14	E	IU	NC40	101.6	8.38	106.4	133.4	71.4	177.8	254	127.4	22.42
4	Z09-04000	14	X	IU	NC40	101.6	8.38	106.4	133.4	68.3	177.8	254	127.4	22.76
4	Z09-04000	14	G	IU	NC40	101.6	8.38	106.4	139.7	61.9	177.8	254	127.4	23.61
4	Z09-04000	14	S	IU	NC40	101.6	8.38	106.4	139.7	50.8	177.8	254	127.4	24.03
4	Z09-04000	14	E	EU	NC46	101.6	8.38	114.3	152.4	82.6	177.8	254	145.26	23.67
4	Z09-04000	14	X, G	EU	NC46	101.6	8.38	114.3	152.4	82.6	177.8	254	145.26	24.12
4	Z09-04000	14	S	EU	NC46	101.6	8.38	114.3	152.4	76.2	177.8	254	145.26	24.46

Specification a						OD of pipe	Wall thickness	Dia. of welded neck	Tool joint					
									OD	ID of pin thread	Length of pin thread	Length of box thread	Bevel diameter	Approximate quality
Model	Product code	Weight lb/ft	Grade	Upset form	Conn	Ddp mm	t mm	mm	mm	mm	mm	mm	c kg/m	
							-12.50%	Max	±0.8	-0.4	±6.4	±6.4		±60.4
4 1/2	Z09-05000	13.75	E	IU	NC46	114.3	6.88	119.1	152.4	85.7	177.8	254	145.26	22.5
4 1/2	Z09-05000	13.75	E	EU	NC50	114.3	6.88	127	168.3	95.3	177.8	254	153.99	23.65
4 1/2	Z09-05001	16.6	E	EU	NC50	114.3	8.56	127	168.3	95.3	177.8	254	153.99	27.51
4 1/2	Z09-05001	16.6	X, G	EU	NC50	114.3	8.56	127	168.3	95.3	177.8	254	153.99	28.07
4 1/2	Z09-05001	16.6	S	EU	NC50	114.3	8.56	127	168.3	88.9	177.8	254	153.99	28.47
4 1/2	Z09-05001	16.6	E	IEU	NC46	114.3	8.56	119.1	158.8	82.6	177.8	254	145.26	27.36
4 1/2	Z09-05001	16.6	X, G	IEU	NC46	114.3	8.56	119.1	158.8	76.2	177.8	254	145.26	27.73
4 1/2	Z09-05001	16.6	S	IEU	NC46	114.3	8.56	119.1	158.8	69.9	177.8	254	145.26	28.04
4 1/2	Z09-05002	20	E	EU	NC50	114.3	10.92	127	168.3	92.1	177.8	254	153.99	32.93
4 1/2	Z09-05002	20	X, G	EU	NC50	114.3	10.92	127	168.3	88.9	177.8	254	153.99	33.63
4 1/2	Z09-05002	20	S	EU	NC50	114.3	10.92	127	168.3	76.2	177.8	254	153.99	34.34
4 1/2	Z09-05002	20	E	IEU	NC46	114.3	10.92	119.1	158.8	76.2	177.8	254	145.26	32.94
4 1/2	Z09-05002	20	X	IEU	NC46	114.3	10.92	119.1	158.8	69.9	177.8	254	145.26	33.69
4 1/2	Z09-05002	20	G	IEU	NC46	114.3	10.92	119.1	158.8	63.5	177.8	254	145.26	33.97
4.5	Z09-05002	20	S	IEU	NC46	114.3	10.92	119.1	158.8	57.2	177.8	254	145.26	34.23
5	Z09-06001	19.5	E	IEU	NC50	127	9.19	130.2	168.3	95.3	177.8	254	153.99	31.79
5	Z09-06002	19.5	X	IEU	NC50	127	9.19	130.2	168.3	88.9	177.8	254	153.99	32.58
5	Z09-06002	19.5	G	IEU	NC50	127	9.19	130.2	168.3	82.6	177.8	254	153.99	32.95
5	Z09-06002	19.5	S	IEU	NC50	127	9.19	130.2	168.3	69.9	177.8	254	153.99	33.6
5	Z09-06002	19.5	E	IEU	5 1/2 FH	127	9.19	130.2	177.8	95.3	203.2	254	170.66	33.22
5	Z09-06002	19.5	X, G	IEU	5 1/2 FH	127	9.19	130.2	177.8	95.3	203.2	254	170.66	33.61
5	Z09-06002	19.5	S	IEU	5 1/2 FH	127	9.19	130.2	184.2	88.9	203.2	254	170.66	34.89
5	Z09-06003	25.6	E	IEU	NC50	127	12.7	130.2	168.3	88.9	177.8	254	153.99	40.73
5	Z09-06004	25.6	X	IEU	NC50	127	12.7	130.2	168.3	76.2	177.8	254	153.99	41.8
5	Z09-06004	25.6	G	IEU	NC50	127	12.7	130.2	168.3	69.9	177.8	254	153.99	42.11
5	Z09-06003	25.6	E	IEU	5 1/2 FH	127	12.7	130.2	177.8	88.9	203.2	254	170.66	42.14
5	Z09-06004	25.6	X	IEU	5 1/2 FH	127	12.7	130.2	177.8	88.9	203.2	254	170.66	42.51
5	Z09-06004	25.6	G	IEU	5 1/2 FH	127	12.7	130.2	184.2	88.9	203.2	254	170.66	43.35
5	Z09-06004	25.6	S	IEU	5 1/2 FH	127	12.7	130.2	184.2	82.6	203.2	254	170.66	43.75
5.5	Z09-07000	21.9	E	IEU	5 1/2 FH	139.7	9.17	144.5	177.8	101.6	203.2	254	170.66	35.43
5.5	Z09-07000	21.9	X	IEU	5 1/2 FH	139.7	9.17	144.5	177.8	95.3	203.2	254	170.66	36.36
5.5	Z09-07000	21.9	G	IEU	5 1/2 FH	139.7	9.17	144.5	184.2	88.9	203.2	254	170.66	37.61
5.5	Z09-07000	21.9	S	IEU	5 1/2 FH	139.7	9.17	144.5	190.5	76.2	203.2	254	180.18	39.27
5.5	Z09-07001	24.7	E	IEU	5 1/2 FH	139.7	10.54	144.5	177.8	101.6	203.2	254	170.66	39.19
5.5	Z09-07001	24.7	X, G	IEU	5 1/2 FH	139.7	10.54	144.5	184.2	88.9	203.2	254	170.66	41.32
5.5	Z09-07001	24.7	S	IEU	5 1/2 FH	139.7	10.54	144.5	190.5	76.2	203.2	254	180.18	42.97
6.625	Z09-08000	25.2	E	IEU	6 5/8 FH	168.28	8.38	176.2	203.2	127	203.2	279.4	195.66	41.03
6.625	Z09-08000	25.2	X	IEU	6 5/8 FH	168.28	8.38	176.2	203.2	127	203.2	279.4	195.66	41.03
6.625	Z09-08000	25.2	G	IEU	6 5/8 FH	168.28	8.38	176.2	209.6	120.7	203.2	279.4	195.66	42.6
6.625	Z09-08000	25.2	S	IEU	6 5/8 FH	168.28	8.38	176.2	215.9	108	203.2	279.4	195.66	44.73
6.625	Z09-08001	27.72	E	IEU	6 5/8 FH	168.28	9.19	176.2	203.2	127	203.2	279.4	195.66	43.79
6.625	Z09-08001	27.72	X, G	IEU	6 5/8 FH	168.28	9.19	176.2	209.6	120.7	203.2	279.4	195.66	45.35
6.625	Z09-08001	27.72	S	IEU	6 5/8 FH	168.28	9.19	176.2	215.9	108	203.2	279.4	195.66	47.48

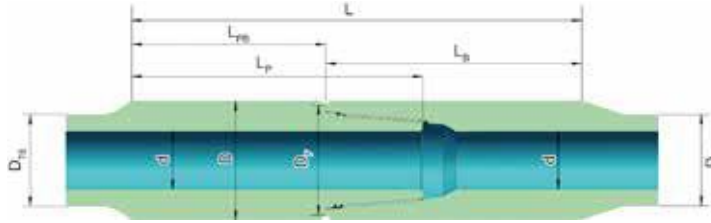

## Specifications - Tool Joints

Connection	Size And Upset type	Nom. Wt. lb/ft	Product	Grade	OD.of Pin and Box D (in)	ID.of Pin d(in)	Bevel Dia. of Pin and Box Shoulder DF (in)	Pin Length LP (in)	Pin Tong Space LPB (in)	Box Tong Space LB	Combined Length of Pin and Box L (in)	Dia. of Box at Elevator Upset DPE (in)	Dia. of Pin at Elevator Upset DTE (in)
NC26 2 3/8 IF	2 3/8 EU	6.65	Z12-0201	E	3 3/8	1 3/4	3 17/64	10	7	8	15	2 9/16	2 9/16
			Z12-0202	x	3 3/8	1 3/4	3 17/64	10	7	8	15	2 9/16	2 9/16
			Z12-0203	G	3 3/8	1 3/4	3 17/64	10	7	8	15	2 9/16	2 9/16
NC31 2 7/8 IF	2 7/8 EU	10.4	Z12-0301	E	4 1/8	2 1/8	3 61/64	10 1/2	7	9	16	3 3/16	3 3/16
			Z12-0302	x	4 1/8	2	3 61/64	10 1/2	7	9	16	3 3/16	3 3/16
			Z12-0303	G	4 1/8	2	3 61/64	10 1/2	7	9	16	3 3/16	3 3/16
			Z12-0304	S	4 3/8	1 5/8	3 61/64	10 1/2	7	9	16	3 3/16	3 3/16
NC38	3 1/2 EU	9.5	Z12-0501	E	4 3/4	2 11/16	4 37/64	12	8	10 1/2	18 1/2	3 7/8	3 7/8
NC38 3 1/2 IF	3 1/2 EU	13.3	Z12-0502	E	4 3/4	2 11/16	4 37/64	12	8	10 1/2	18 1/2	3 7/8	3 7/8
			Z12-0503	x	5	2 9/16	4 37/64	12	8	10 1/2	18 1/2	3 7/8	3 7/8
			Z12-0504	G	5	2 7/16	4 37/64	12	8	10 1/2	18 1/2	3 7/8	3 7/8
			Z12-0505	S	5	2 1/8	4 37/64	12	8	10 1/2	18 1/2	3 7/8	3 7/8
	15.5	Z12-0506	E	5	2 9/16	4 37/64	12	8	10 1/2	18 1/2	3 7/8	3 7/8	
		Z12-0507	x	5	2 7/16	4 37/64	12	8	10 1/2	18 1/2	3 7/8	3 7/8	
Z12-0508	G	5	2 1/8	4 37/64	12	8	10 1/2	18 1/2	3 7/8	3 7/8	3 7/8		
NC40 4 FH	3 1/2 EU	15.5	Z12-0601	S	5 1/2	2 1/4	5 1/64	12 1/2	8	10 1/2	18 1/2	3 7/8	3 7/8
	4 IU	14	Z12-0602	E	5 1/4	2 13/16	5 1/64	11 1/2	7	10	17	4 3/16	4 3/16
			Z12-0603	x	5 1/4	2 11/16	5 1/64	11 1/2	7	10	17	4 3/16	4 3/16
			Z12-0604	G	5 1/2	2 7/16	5 1/64	11 1/2	7	10	17	4 3/16	4 3/16
Z12-0605	S	5 1/2	2	5 1/64	11 1/2	7	10	17	4 3/16	4 3/16			
NC46 4 IF	4 EU	14	Z12-0801	E	6	3 1/4	5 23/32	11 1/2	7	10	17	4 1/2	4 1/2
			Z12-0802	x	6	3 1/4	5 23/32	11 1/2	7	10	17	4 1/2	4 1/2
			Z12-0803	G	6	3 1/4	5 23/32	11 1/2	7	10	17	4 1/2	4 1/2
			Z12-0804	S	6	3	5 23/32	11 1/2	7	10	17	4 1/2	4 1/2
	4 1/2IU	13.75	Z12-0805	E	6	3 3/8	5 23/32	11 1/2	7	10	17	4 11/16	4 11/16
	4 1/2	16.6	Z12-0806	E	6 1/4	3 1/4	5 23/32	11 1/2	7	10	17	4 11/16	4 11/16
			Z12-0807	x	6 1/4	3	5 23/32	11 1/2	7	10	17	4 11/16	4 11/16
			Z12-0808	G	6 1/4	3	5 23/32	11 1/2	7	10	17	4 11/16	4 11/16
	IEU	20	Z12-0809	S	6 1/4	2 3/4	5 23/32	11 1/2	7	10	17	4 11/16	4 11/16
	Z12-0810		E	6 1/4	3	5 23/32	11 1/2	7	10	17	4 11/16	4 11/16	
	Z12-0811		x	6 1/4	2 3/4	5 23/32	11 1/2	7	10	17	4 11/16	4 11/16	
	Z12-0812		G	6 1/4	2 1/2	5 23/32	11 1/2	7	10	17	4 11/16	4 11/16	
	Z12-0813	S	6 1/4	2 1/4	5 23/32	11 1/2	7	10	17	4 11/16	4 11/16		

## Specifications - Tool Joints

Connection	Size And Upset type	Nom. Wt. lb/ft	Product Code	Grade	OD.of Pin and Box D (in)	ID. of Pin d(in)	Bevel Dia. of Pin and Box Shoulder DF (in)	Pin Length LP (in)	Pin Tong Space LPB (in)	Box Tong Space LB (in)	Combined Length of Pin and Box L (in)	Dia. of Box at Elevator Upset DPE (in)	Dia. of Pin at Elevator Upset DTE (in)	
NC50	4 1/2 EU	13.75	Z12-0901	E	6 5/8	3 3/4	6 1/16	11 1/2	7	10	17	5	5	
			16.6	Z12-0902	E	6 5/8	3 3/4	6 1/16	11 1/2	7	10	17	5	5
				Z12-0903	x	6 5/8	3 3/4	6 1/16	11 1/2	7	10	17	5	5
		20	Z12-0904	G	6 5/8	3 3/4	6 1/16	11 1/2	7	10	17	17	5	5
			Z12-0905	S	6 5/8	3 1/2	6 1/16	11 1/2	7	10	17	17	5	5
			Z12-0906	E	6 5/8	3 5/8	6 1/16	11 1/2	7	10	17	17	5	5
		20	Z12-0907	x	6 5/8	3 1/2	6 1/16	11 1/2	7	10	17	17	5	5
			Z12-0908	G	6 5/8	3 1/2	6 1/16	11 1/2	7	10	17	17	5	5
			Z12-0909	S	6 5/8	3	6 1/16	11 1/2	7	10	17	17	5	5
5 IEU	5 IEU	19.5	Z12-0910	E	6 5/8	3 3/4	6 1/16	11 1/2	7	10	17	5 1/8	5 1/8	
			Z12-0911	x	6 5/8	3 1/2	6 1/16	11 1/2	7	10	17	5 1/8	5 1/8	
			Z12-0912	G	6 5/8	3 1/4	6 1/16	11 1/2	7	10	17	5 1/8	5 1/8	
			Z12-0913	S	6 5/8	2 3/4	6 1/16	11 1/2	7	10	17	5 1/8	5 1/8	
		25.6	Z12-0914	E	6 5/8	3 1/2	6 1/16	11 1/2	7	10	17	17	5 1/8	5 1/8
			Z12-0915	x	6 5/8	3	6 1/16	11 1/2	7	10	17	17	5 1/8	5 1/8
5 1/2 FH	5 IEU	19.5	Z12-2401	E	7	3 3/4	6 23/32	13	8	10	18	5 1/8	5 1/8	
			Z12-2402	x	7	3 3/4	6 23/32	13	8	10	18	5 1/8	5 1/8	
			Z12-2403	G	7	3 3/4	6 23/32	13	8	10	18	18	5 1/8	5 1/8
			Z12-2404	S	7 1/4	3 1/2	6 23/32	13	8	10	18	18	5 1/8	5 1/8
		25.6	Z12-2405	E	7	3 1/2	6 23/32	13	8	10	18	18	5 1/8	5 1/8
			Z12-2406	x	7	3 1/2	6 23/32	13	8	10	18	18	5 1/8	5 1/8
			Z12-2407	G	7 1/4	3 1/2	6 23/32	13	8	10	18	18	5 1/8	5 1/8
			Z12-2408	S	7 1/4	3 1/4	6 23/32	13	8	10	18	18	5 1/8	5 1/8
5 1/2 IEU	5 1/2 IEU	21.9	Z12-2409	E	7	4	6 23/32	13	8	10	18	5 11/16	5 11/16	
			Z12-2410	x	7	3 3/4	6 23/32	13	8	10	18	5 11/16	5 11/16	
			Z12-2411	G	7 1/4	3 1/2	6 23/32	13	8	10	18	18	5 11/16	5 11/16
			Z12-2412	S	7 1/2	3	7 3/32	13	8	10	18	18	5 11/16	5 11/16
		24.7	Z12-2413	E	7	4	6 23/32	13	8	10	18	18	5 11/16	5 11/16
			Z12-2414	x	7 1/4	3 1/2	6 23/32	13	8	10	18	18	5 11/16	5 11/16
			Z12-2415	G	7 1/4	3 1/2	6 23/32	13	8	10	18	18	5 11/16	5 11/16
			Z12-2416	S	7 1/2	3	7 3/32	13	8	10	18	18	5 11/16	5 11/16
6 5/8 FH	6 5/8 IEU	25.2	Z12-2501	E	8	5	7 45/64	13	8	11	19	6 15/16	6 15/16	
			Z12-2502	x	8	5	7 45/64	13	8	11	19	19	6 15/16	6 15/16
			Z12-2503	G	8 1/4	4 3/4	7 45/64	13	8	11	19	19	6 15/16	6 15/16
			Z12-2504	S	8 1/2	4 1/4	7 45/64	13	8	11	19	19	6 15/16	6 15/16
		27.7	Z12-2505	E	8	5	7 45/64	13	8	11	19	19	6 15/16	6 15/16
			Z12-2506	x	8 1/4	4 3/4	7 45/64	13	8	11	19	19	6 15/16	6 15/16
			Z12-2507	G	8 1/4	4 3/4	7 45/64	13	8	11	19	19	6 15/16	6 15/16
			Z12-2508	S	8 1/2	4 1/4	7 45/64	13	8	11	19	19	6 15/16	6 15/16



Drill Collar is the basic component in the BHA which provides weight on the bit for drilling and keeps the drill string in tension.

TIANHE Drill Collar is manufactured from AISI 4145H modified quenched and tempered steel and is heat treated along its entire length for uniform toughness and durability. Strict metallurgical tests are performed per specifications to ensure that the heat treatment produces consistent and maximum hardness through the depth of the bar.

## Features and Benefits

- A hardness range of 285 to 341 BH N and a Charpy impact value of 40 lbs/ft are guaranteed for evenly distributed 16 points in any cross sections at room temperature;

- Connections are phosphate coated after machining to protect the threads from corrosive elements and to prevent galling upon initial make-up;
- Thread roots are cold rolled on API and H-90 connections;
- Pressed steel thread protectors are supplied for all drill collar that are equipped with standard connections

## When ordering please specify:

- Drill collar OD and ID;
- Overall length;
- Connections required (size and type);
- Special features desired, for example:
  - Slick or Spiral;
  - Stress Relief Features;
  - Slip and/or Elevator Recess;
  - Hardbanding;

## Specifications - Drill Collar

Number And Connection Table	Product Code	OD		ID		Length mm	Bevel Diameter mm	Bending Strength Ratio
		mm	in	mm	in			
NC23-31	Z01/Z02-01000	79.4	3 1/8	31.8	1 1/4	9150	76.2	2.57:1
NC26-35(2 3/8 IF)	Z01/Z02-02000	88.9	3 1/2	38.1	1 1/2	9150	84.5	2.42:1
NC31-41(2 7/8 IF)	Z01/Z02-04000	104.8	4 1/8	50.8	2	9150	101.6	2.43:1
NC35-47	Z01/Z02-06000	120.6	4 3/4	50.8	2	9150	114.7	2.58:1
NC38-50(3 1/2 IF)	Z01/Z02-07000	127	5	57.2	2 1/4	9150	121	2.38:1
NC44-60	Z01/Z02-23000	152.4	6	57.2	2 1/4	9150 or 9450	144.5	2.49:1
NC44-60	Z01/Z02-23100	152.4	6	71.4	2 13/16	9150 or 9450	144.5	2.84:1
NC44-62	Z01/Z02-08000	158.8	6 1/4	57.2	2 1/4	9150 or 9450	149.2	2.91:1
NC46-62(4 IF)	Z01/Z02-08100	158.8	6 1/4	71.4	2 13/16	9150 or 9450	150	2.63:1
NC46-65(4 IF)	Z01/Z02-09000	165.1	6 1/2	57.2	2 1/4	9150 or 9450	154.8	2.76:1
NC46-65(4 IF)	Z01/Z02-09100	165.1	6 1/2	71.4	2 13/16	9150 or 9450	154.8	3.05:1
NC46-67(4 IF)	Z01/Z02-11000	171.4	6 3/4	57.2	2 1/4	9150 or 9450	159.5	3.18:1
NC50-67(4 1/2 IF)	Z01/Z02-11100	171.4	6 3/4	71.4	2 13/16	9150 or 9450	159.5	2.37:1
NC50-70(4 1/2 IF)	Z01/Z02-12000	177.8	7	57.2	2 1/4	9150 or 9450	164.7	2.54:1
NC50-70(4 1/2 IF)	Z01/Z02-12100	177.8	7	71.4	2 13/16	9150 or 9450	164.7	2.73:1
NC50-72(4 1/2 IF)	z01/z02-24000	184.2	7 1/4	71.4	2 13/16	9150 or 9450	169.5	3.12:1
NC56-77	Z01/Z02-13000	196.8	7 3/4	71.4	2 13/16	9150 or 9450	185.3	2.70:1
NC56-80	Z01/Z02-14000	203.2	8	71.4	2 13/16	9150 or 9450	190.1	3.02:1
6 5/8 REG	Z01/Z02-15000	209.6	8 1/4	71.4	2 13/16	9150 or 9450	195.7	2.93:1
NC61-90	Z01/Z02-16000	228.6	9	71.4	2 13/16	9150 or 9450	212.7	3.17:1
7 5/8 REG	Z01/Z02-17000	241.3	9 1/2	76.2	3	9150 or 9450	223.8	2.81:1
NC70-97	Z01/Z02-25000	247.6	9 3/4	76.2	3	9150 or 9450	232.6	2.57:1
NC70-100	Z01/Z02-18000	254	10	76.2	3	9150 or 9450	237.3	2.81:1
8 5/8 REG	Z01/Z02-19000	279.4	11	76.2	3	9150 or 9450	266.7	2.84:1



Spiral Drill Collar (Z02)

Standard Drill Collar (Z01)

# SPECIAL FEATURES FOR DRILL COLLAR



## Spiral Grooving

In order to reduce differential pressure sticking, the surface of drill collars can be spiral-grooved.

Spiral Grooved Drill Collars: usual Sizes									
OD	4 3/4"	6 1/4"	6 3/4"	7 1/4"	7 1/2"	8"	9 1/2"	10"	11"
Depth of cut (in)	7/32	9/32	5/16	11/32	11/32	3/8	13/32	7/16	15/32
	±1/32	±1/16	±1/16	±1/16	±1/16	±1/16	±3/12	±3/32	±3/32
Spiral pitch (in)	38	42	46	64	64	68	72	76	80
	±1	±2	±3	±4	±5	±6	±7	±8	±9

note 1-Loss of weight is approximately 4%, compared to slick drill collars.  
note 2-Length of spiraled section allows reconditioning of connections.

## Stress Relief Groove & Bore Back Box

Stress relief grooves improve bending strength of pin and box connections and, therefore, durability. Stress relief grooves for box and pin are defined by API.

Bore back box is a gradual reduction of internal diameter by gradually increasing material cross sectional area at critical section. This will ultimately drastically reduce stress concentration during static / dynamic loading and prevents box connections from failure.

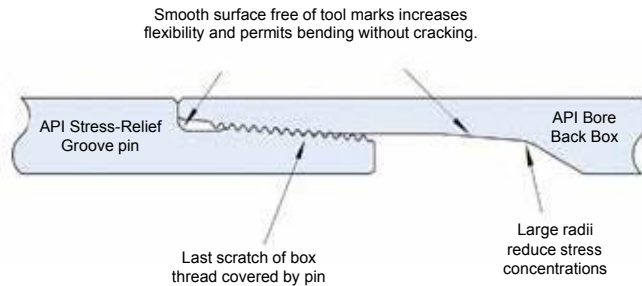

## Hardbanding

We provide several hardbanding materials for customer's choice: Arnco-100xT, Arnco-300xT, TCS-8000;

## Slip and Elevator Recess

Slip and elevator recesses improve downhole handling efficiency and safety. Slip and elevator recesses are machined in accordance with API 7-1.

### Recommended Hardbanding Location

-Drill collars with slip and elevator recesses (ZIP)

- 4" long wear pad above elevator recess
- 1" long wear pad above slip recess.
- 10" long wear pad under slip recess

-Drill collars with slip recess:

- 10" long wear pad under slip recess,
- 4" long wear pad above slip recess.

-Drill collars without slip and elevator recesses:

- 10" long wear pad at 30" from pin shoulder.

## Drill Collars

OD (in)	A (in)	B (in)	R (in)
10	9 1/8	9 1/2	1/4
9 3/4	8 7/8	9 1/4	1/4
9 1/2	8 5/8	9	1/4
9 1/4	8 3/8	8 3/4	1/4
9	8 1/8	8 1/2	1/4
8 1/2	7 3/4	8	3/16
8	7 1/4	7 1/2	3/16
7 3/4	7	7 1/4	3/16
7 1/2	6 3/4	7	3/16
7 1/4	6 1/2	6 3/4	3/16
7	6 1/4	6 1/2	3/16
6 3/4	6	6 1/4	3/16
6 1/2	5 7/8	6	1/8
6 1/4	5 5/8	5 3/4	1/8
6	5 3/8	5 1/2	1/8
5 3/4	5 1/8	5 1/4	1/8
4 3/4	4 1/4	4 3/8	1/8
4 1/8	3 11/16	3 3/4	1/8

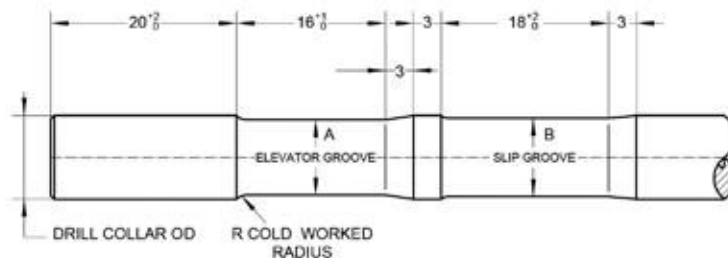

Spiral Drill Collar With Slip and Elevator Recess (Z02)

TIANHE non-magnetic drill collars are made from non-magnetic steel bars with low-strength by combining a proper chemical analysis and rotary hammer forging process with low magnetic permeability and excellent machinability. It will not interfere with the specialized directional equipment but rather will enhance the performance of the drilling operation.

The non-magnetic drill collars function as a housing for the MWD tools, while at the same time provide the weight for drill string. TIANHE non-magnetic drill collars are suitable for all types of drilling including straight and directional applications.

Each drill collar is fully inspected by our internal inspection department. All data obtained are recorded on the inspection certificate furnished with each drill collar. API monogram, serial number, OD, ID, type and size of connections are stamped on the recessed mill flats.

We manufacture three type of non-magnetic drill collars according to the customers' order; include Slick, Spiral, and Flex non-Mag Drill Collars.

### Slick Non-Mag Drill Collar

TIANHE Slick non-Mag Drill Collar provides the required weight on bit, and will not interfere with the directional drilling ability.

### Spiral Non-Mag Drill Collar

TIANHE Spiral non-Mag Drill Collar is designed to allow greater flow area for drilling fluids, while providing the benefits of non-mag steel for complex drilling programs.

### Flex Non-Mag Drill Collar

TIANHE Flex non-Mag Drill Collar is thinner and more flexible than standard drill collar. Their ability to make short radius turns, bend for high build angles, and pass through severe doglegs makes them ideal for use in directional and horizontal applications. Manufactured with non-mag steel, this drill collar is well suited for housing MWD equipment.



non-Magnetic  
Drill Collar  
(Z10)

Spiral  
non-Magnetic  
Drill Collar  
(Z11)

non-Magnetic  
Flex Drill Collar  
(Z12)

Heavy Weight Drill Pipe (HWDP) is an intermediate weight drill stem component which is used in conjunction with the drill pipes and drill collars. TIANHE HWDP is available in standard, spiral and non-magnetic designs. In some applications, heavy-weight drill pipes also can be used instead of the drill collars.

TIANHE HWDP is made from one-piece AISI 4145H modified quenched and tempered steel. It is designed for tough drilling environment in vertical and directional wells. TIANHE HWDP is a transition member between drill collar and drill pipe. For directional holes HWDP provides weight-on-bit and additional stiffness to prevent buckling.

## Features and Benefits

- A center upset or wear pad to increase tube life, reduce hole drag and differential sticking problems;
- Connections are completed (phosphate coated) to protect them from the elements after machining and to help prevent galling upon initial make-up;
- Thread roots are cold rolled on API and H-90 connections. And pressed steel thread protectors are supplied for standard connections;
- Hardbanding and internal coating can be provided on customer's request.

## Specifications - Heavy Weight Drill Pipe

Size(in)	Product Code	O. D. (In) P.	I.D. (in)	Tool Joint O.D. (in)	Tool Joint I.D. (in)	Connection	Max.Elevator Diameter (in)	Central upset Dia. (in)	Min.Drift Dia. Size (in)
3 1/2	Z07-03000	3 1/2	2 1/4	4 3/4	2 1/4	NC38	3 7/8	4	2
	Z07-03001		2 1/16	(4 7/8, 5)	2 1/16				1 13/16
4	Z07-04000	4	2 1/2	5 1/4	2 1/2	NC40	4 3/16	4 1/2	2 1/4
	Z07-04001		2 9/16		2 9/16				2 5/16
4 1/2	Z07-05000	4 1/2	2 11/16	6 1/4	2 11/16	NC46	4 11/16	5	2 7/16
	Z07-05001		2 3/4		2 3/4				2 1/2
	Z07-05002		2 13/16		2 13/16				2 9/16
5	Z07-06000	5	3	6 5/8	3	NC50	5 1/8	5 1/2	2 3/4
5 1/2	Z07-07000	5 1/2	3 1/4	(7 1/4, 7 1/2)	3 1/4	5 1/2 FH	5 11/16	6	3
	Z07-07001		3 3/8		3 3/8				3 1/8
	Z07-07002		3 7/8		3 7/8				3 5/8
	Z07-07003		4		4				3 3/4
6 5/8	Z07-08000	6 5/8	4	8 (8 1/4, 8 1/2)	4	6 5/8 FH	6 15/16	7 1/8	3 3/4
	Z07-08001		4 1/2		4 1/2				4 1/4
	Z07-08002				5				4 3/4

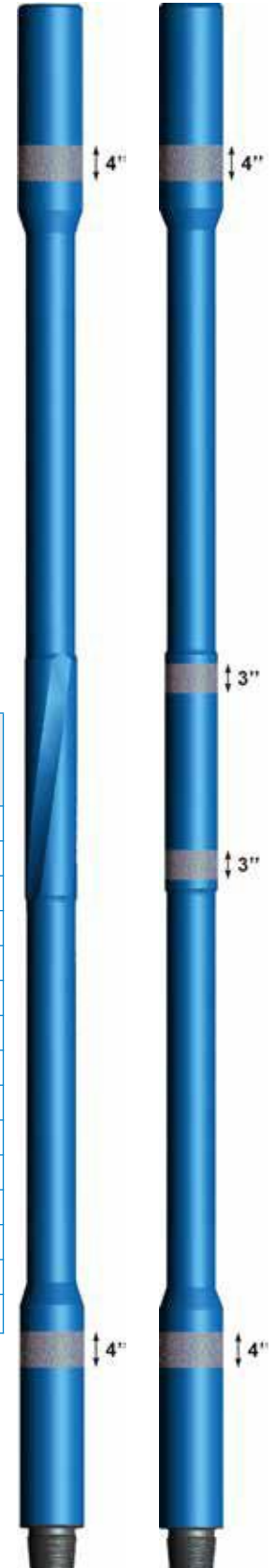

Spiral Heavy Weight Drill Pipe (Z08)      Heavy Weight Drill Pipe (Z07)

## Downhole Motor

Downhole motor is a kind of downhole dynamic drilling tool driven by the power of drilling mud. Mud stream from the outlet of a mud pump flows through a by-pass valve into the motor. This stream produces pressure loss at both inlet and outlet of the pump, to push the rotor into rotating, and to transmit the torque and speed onto the bit. The downhole motor property mainly depends on its property parameters.

## Motor Assembly

Downhole motor rotor is manufactured from high quality alloy steel, while s-rotor is made of rubber. High force and tearing strength of the rubber stator allows the tool to run in the high temperatures (about 180 °C ) and high oil mud condition. All these benefits help to maintain effective operation.

We produce the downhole motor with an external coating on the motor rotor that gives the tool a much longer service life.

## Cardan Shaft Assembly

The function of cardan shaft is to convert planetary motion into fixed constant rotation of drive shaft, to transmit torque and speed from motor on the drive shaft and to the bit.

## Drive Shaft Assembly

The driveshaft assembly converts the eccentric motion of the rotor into concentric rotation for the bearing assembly. It also accommodates any angle set on the adjustable bent housing (or fixed bend housing) and carries the thrust load from the rotor caused by the pressure drop across the power section.

The drive shaft assembly are forged using superior alloy steel, it gives the shaft assembly good strength and toughness and also greatly improve the anti-fatigue capacity during the rotating movement, thus giving the downhole motor a much longer service life.

TIANHE Downhole motors come in sizes ranging from  $\Phi 43\text{mm}$  to  $\Phi 286\text{mm}$ .



By-Pass valve Assembly



Anti-Drop Assembly



Motor Assembly



Drive Shaft Assembly



Cardan Shaft Assembly



Downhole Motor (LZ)



Model	Specification		Drill bit size		Conn. thread		Lobe	stage	Flow rate gpm		Flow rate lpm		Rotating speed rpm		R / unit volume		Working pressure drop	
	in	mm	in	mm	Upper end	Lower end			min	max	min	max	min	max	rev/gal	rev/l	psi	Mpa
5LZ43T-3	1 11/16	43	1 7/8-3	48-76	1 AMMT	1 AMMT	5:6	3	12	25	45	96	262	559	22.03	5.82	348	2
5LZ54T-3	2 1/8	54	2 3/8-3 1/2	60-89	1 1/2Reg 1 1/2AMMT	1 1/2Reg	5:6	3	16	50	60	190	164	519	10.33	2.73	348	2
5LZ60T-3	2 3/8	60	3 1/2-4 3/8	79-111	1 1/2 AMMT	1 1/2 AMMT	5:6	3	21	74	80	280	122	428	5.79	1.53	348	2
5LZ73T-3	2 7/8	73	3 3/4-4 3/4	95-121	2-3/8 Reg	2-3/8 Reg	5:6	3	40	132	150	500	150	500	3.79	1.00	348	2
5LZ73T-4	2 7/8	73	3 3/4-4 3/4	95-121	2-3/8 Reg	2-3/8 Reg	5:6	4	40	95	150	360	201	482	5.07	1.34	464	3
4LZ79T-4	3 1/8	79	3 3/4-4 3/4	95-121	2-3/8 Reg	2-3/8 Reg	4:5	4	40	132	150	500	131	435	3.29	0.87	464	3
7LZ79T-4	3 1/8	79	3 3/4-4 3/4	95-121	2-3/8 Reg	2-3/8 Reg	7:8	4	40	132	150	500	101	335	2.54	0.67	464	3
4LZ89T-5	3 1/2	89	4 1/2-5 7/8	114-149	2-3/8 Reg	2-3/8 Reg	4:5	5	50	151	190	570	160	479	3.18	0.84	580	4
5LZ89T-3	3 1/2	89	4 1/2-5 7/8	114-149	2-3/8 Reg	2-3/8 Reg	5:6	3	66	151	250	570	101	231	1.53	0.40	348	2
7LZ89T-3	3 1/2	89	4 1/2-5 7/8	114-149	2-3/8 Reg	2-3/8 Reg	7:8	3	50	151	190	570	74	222	1.48	0.39	348	2
5LZ95T-5	3 3/4	95	4 5/8-5 7/8	118-149	2-7/8 Reg 2 3/8IF	2-7/8 Reg	5:6	5	85	211	320	800	128	320	1.51	0.40	580	4
7LZ95T-5	3 3/4	95	4 5/8-5 7/8	118-149	2-7/8 Reg 2 3/8IF	2-7/8 Reg	7:8	5	85	211	320	800	163	408	1.93	0.51	580	4
7LZ95T-6.5	3 3/4	95	4 5/8-5 7/8	118-149	2-7/8 Reg 2 3/8IF	2-7/8 Reg	7:8	6.5	85	211	320	800	163	408	1.93	0.51	754	5
5LZ105-7	4 1/8	105	4 3/4-6	121-152	2-7/8 Reg 2 3/8IF	2-7/8 Reg	5:6	7	79	159	300	600	162	324	2.04	0.54	812	6
7LZ105-2.8	4 1/8	105	4 3/4-6	121-152	2-7/8 Reg 2 3/8IF	2-7/8 Reg	7:8	2.8	95	190	360	720	130	259	1.36	0.36	325	2
2LZ120T-6	4 3/4	120	5 7/8-7 7/8	149-200	3 1/2Reg 3 1/2IF	3 1/2Reg	2:3	6	161	349	610	1320	323	700	2.01	0.53	696	5
5LZ120T-4	4 3/4	120	5 7/8-7 7/8	149-200	3 1/2Reg 3 1/2IF	3 1/2Reg	5:6	4	161	349	610	1320	134	290	0.83	0.22	464	3
5LZ120T-5	4 3/4	120	5 7/8-7 7/8	149-200	3 1/2Reg 3 1/2IF	3 1/2Reg	5:6	5	161	349	610	1320	134	290	0.83	0.22	580	4
7LZ120T-4	4 3/4	120	5 7/8-7 7/8	149-200	3 1/2Reg 3 1/2IF	3 1/2Reg	7:8	4	161	349	610	1320	114	247	0.71	0.19	464	3
7LZ120T-5	4 3/4	120	5 7/8-7 7/8	149-200	3 1/2Reg 3 1/2IF	3 1/2Reg	7:8	5	161	349	610	1320	114	247	0.71	0.19	580	4
7LZ120T-7	4 3/4	120	5 7/8-7 7/8	149-200	3 1/2Reg 3 1/2IF	3 1/2Reg	7:8	7	161	349	610	1320	158	342	0.98	0.26	812	6
9LZ120T-4	4 3/4	120	5 7/8-7 7/8	149-200	3 1/2Reg 3 1/2IF	3 1/2Reg	9:10	4	100	251	380	950	61	152	0.61	0.16	464	3
5LZ159T-5	6 1/4	159	6 3/4-8 3/4	171-222	4 1/2Reg 4 IF	4 1/2Reg	5:6	5	251	499	950	1890	114	227	0.45	0.12	580	4
7LZ159T-5	6 1/4	159	6 3/4-8 3/4	171-222	4 1/2Reg 4 IF	4 1/2Reg	7:8	5	251	499	950	1890	95	189	0.38	0.10	580	4
5LZ165T-5	6 1/2	165	8 3/8-9 7/8	213-251	4 1/2Reg 4 IF	4 1/2Reg	5:6	5	251	499	950	1890	114	227	0.45	0.12	580	4
7LZ165T-5	6 1/2	165	8 3/8-9 7/8	213-251	4 1/2Reg 4 IF	4 1/2Reg	7:8	5	251	499	950	1890	95	189	0.38	0.10	580	4
2LZ172T-8	6 3/4	172	8 3/8-9 7/8	213-251	4 1/2Reg 4 1/2IF	4 1/2Reg	2:3	8	301	600	1140	2270	228	454	0.76	0.20	928	6
4LZ172T-7	6 3/4	172	8 3/8-9 7/8	213-251	4 1/2Reg 4 1/2IF	4 1/2Reg	4:5	7	301	600	1140	2270	125	250	0.42	0.11	812	6
5LZ172T-5	6 3/4	172	8 3/8-9 7/8	213-251	4 1/2Reg 4 1/2IF	4 1/2Reg	5:6	5	301	600	1140	2270	104	208	0.35	0.09	580	4
5LZ172T-6	6 3/4	172	8 3/8-9 7/8	213-251	4 1/2Reg 4 1/2IF	4 1/2Reg	5:6	6	301	600	1140	2270	104	208	0.35	0.09	696	5
7LZ172T-5	6 3/4	172	8 3/8-9 7/8	213-251	4 1/2Reg 4 1/2IF	4 1/2Reg	7:8	5	301	600	1140	2270	86	170	0.28	0.08	580	4
7LZ172T-6	6 3/4	172	8 3/8-9 7/8	213-251	4 1/2Reg 4 1/2IF	4 1/2Reg	7:8	6	301	600	1140	2270	86	170	0.28	0.08	696	5
7LZ172T-5.7	6 3/4	172	8 3/8-9 7/8	213-251	4 1/2Reg 4 1/2IF	4 1/2Reg	7:8	5.7	301	600	1140	2270	77	153	0.26	0.07	661	5
7LZ172T-7.5	6 3/4	172	8 3/8-9 7/8	213-251	4 1/2Reg 4 1/2IF	4 1/2Reg	7:8	7.5	301	600	1140	2270	104	207	0.35	0.09	870	6
5LZ203T-5	8	203	9 7/8-12 1/4	251-311	6 5/8 Reg	6 5/8 Reg	5:6	5	301	600	1140	2270	84	167	0.28	0.07	580	4
7LZ203T-4	8	203	9 7/8-12 1/4	251-311	6 5/8 Reg	6 5/8 Reg	7:8	4	301	901	1140	3410	61	181	0.20	0.05	464	3
7LZ203T-5	8	203	9 7/8-12 1/4	251-311	6 5/8 Reg	6 5/8 Reg	7:8	5	301	650	1140	2460	75	162	0.25	0.07	580	4
7LZ216T-5	8 1/2	216	12 1/4-15 1/2	311-394	6 5/8 Reg	6 5/8 Reg	7:8	5	301	901	1140	3410	57	171	0.19	0.05	580	4
5LZ228T-5	9	228	12 1/4-15 1/2	311-394	6 5/8 Reg	6 5/8 Reg	5:6	5	301	901	1140	3410	71	213	0.24	0.06	580	4
7LZ228T-5	9	228	12 1/4-15 1/2	311-394	6 5/8 Reg	6 5/8 Reg	7:8	5	301	901	1140	3410	57	171	0.19	0.05	580	4
3LZ244-6	9 5/8	244	12 1/4-17 1/2	311-445	6 5/8 Reg 7 5/8 Reg	6 5/8 Reg 7 5/8 Reg	3:4	6	600	1199	2270	4540	130	259	0.22	0.06	696	5
5LZ244T-4	9 5/8	244	12 1/4-17 1/2	311-445	6 5/8 Reg 7 5/8 Reg	6 5/8 Reg 7 5/8 Reg	5:6	4	600	1199	2270	4540	92	184	0.15	0.04	464	3
5LZ244T-6	9 5/8	244	13 1/4-17 1/2	311-446	6 5/8 Reg 7 5/8 Reg	6 5/8 Reg 7 5/8 Reg	5:6	6	600	1199	2270	4540	92	184	0.15	0.04	696	5
7LZ244T-4	9 5/8	244	12 1/4-17 1/2	311-445	6 5/8 Reg 7 5/8 Reg	6 5/8 Reg 7 5/8 Reg	7:8	4	600	1199	2270	4540	66	132	0.11	0.03	464	3
7LZ244T-5	9 5/8	244	12 1/4-17 1/2	311-445	6 5/8 Reg 7 5/8 Reg	6 5/8 Reg 7 5/8 Reg	7:8	5	600	1199	2270	4540	82	163	0.14	0.04	580	4
7LZ244T-6	9 5/8	244	12 1/4-17 1/2	311-445	6 5/8 Reg 7 5/8 Reg	6 5/8 Reg 7 5/8 Reg	7:8	6	600	1199	2270	4540	82	163	0.14	0.04	696	5
3LZ286T-3.6	11 1/4	286	14 3/4-26	375-660	6 5/8 Reg 7 5/8 Reg	6 5/8 Reg 7 5/8 Reg	3:4	3.6	901	1500	3410	5680	107	179	0.12	0.03	418	3

Max. pressure drop		Working torque		Max. torque		Output power		Working WOB		Max. bit weight		Weight		Length		Max. starting torque
psi	Mpa	lb. ft	N. m	lb. ft	N. m	bhp	kW	kb	kN	lb	kN	lb	kg	ft	m	kN. m
492	3.39	48	66	68	93	5	4	660	3	1320	6	49	22	7.81	2.38	16
492	3.39	103	140	146	198	11	8	880	3	1760	6	49	34	7.81	2.83	16
492	3.39	184	250	260	353	16	12	1100	4	2200	8	75	65	9.28	3.60	35
492	3.39	282	382	398	540	28	21	2640	5	4400	10	143	84	11.81	3.60	62
656	4.52	280	380	396	537	27	20	2640	12	4400	20	185	98	11.81	4.20	95
656	4.52	432	585	610	827	38	28	3520	12	5500	25	216	116	13.78	4.20	95
656	4.52	561	760	792	1074	38	28	3520	16	5500	25	256	116	13.78	4.20	146
819	5.65	559	758	790	1071	54	40	4400	16	7700	35	256	183	13.78	5.00	190
492	3.39	696	943	983	1333	32	24	4400	20	7700	35	403	180	16.40	4.90	189
492	3.39	722	979	1020	1383	32	24	4400	20	7700	35	397	180	16.08	4.90	236
819	5.65	1174	1592	1658	2248	76	57	6600	30	12100	55	397	232	16.08	5.38	245
819	5.65	920	1248	1300	1762	76	57	6600	30	12100	55	511	232	17.65	5.38	398
1065	7.35	1196	1622	1690	2291	98	73	6600	30	12100	55	511	275	17.65	6.38	312
1147	7.91	1217	1650	1720	2331	80	59	7700	35	17600	80	606	297	20.93	5.45	406
459	3.16	730	990	1032	1399	38	28	7700	35	17600	80	655	248	17.88	4.55	413
983	6.78	1063	1441	1502	2036	150	112	11000	50	22000	100	547	461	14.93	6.30	248
656	4.52	1708	2315	2412	3270	100	75	11000	50	22000	100	1016	461	20.65	6.30	360
819	5.65	2134	2894	3015	4087	125	93	11000	50	22000	100	1016	531	20.65	7.12	579
656	4.52	2006	2720	2833	3841	100	75	11000	50	22000	100	1171	461	23.36	6.30	723
819	5.65	2508	3400	3542	4802	125	93	11000	50	22000	100	1016	531	20.65	7.12	680
1147	7.91	2538	3440	3584	4859	175	131	11000	50	22000	100	1171	535	23.36	7.20	850
656	4.52	2348	3183	3316	4496	72	54	11000	50	22000	100	1179	461	23.62	6.30	860
819	5.65	3913	5305	5527	7494	179	133	17600	80	35200	160	1016	964	20.65	7.65	796
819	5.65	4696	6366	6633	8992	179	133	17600	80	35200	160	2125	964	25.10	7.65	1326
819	5.65	3913	5305	5527	7494	179	133	17600	80	35200	160	2125	1055	25.10	7.65	1592
819	5.65	4696	6366	6633	8992	179	133	17600	80	35200	160	2326	1055	25.10	7.65	1326
1311	9.04	3757	5093	5306	7194	344	257	22000	100	37400	170	2326	1315	25.10	9.90	1592
1147	7.91	5976	8102	8442	11445	301	224	22000	100	37400	170	2899	1273	32.48	9.22	1273
819	5.65	5123	6946	7236	9811	215	160	22000	100	37400	170	2806	1105	30.25	8.32	2026
983	6.78	6148	8335	8684	11773	258	192	22000	100	37400	170	2436	1273	27.30	9.22	1736
819	5.65	6261	8488	8844	11990	215	160	22000	100	37400	170	2806	1105	30.25	8.32	2084
983	6.78	7513	10186	10612	14388	258	192	22000	100	37400	170	2436	1273	27.30	9.22	2122
934	6.44	7933	10756	11206	15192	245	183	22000	100	37400	170	2806	1315	30.25	9.90	2546
1229	8.48	7727	10476	10914	14797	322	240	22000	100	37400	170	2899	1315	32.48	9.90	2689
819	5.65	6367	8633	8994	12193	215	160	37400	170	55000	250	2899	1648	32.48	8.37	2619
656	4.52	7074	9590	9991	13546	258	193	37400	170	55000	250	3633	1648	27.46	8.37	2158
819	5.65	7142	9683	10088	13677	233	174	37400	170	55000	250	3633	1648	27.46	8.37	2398
819	5.65	9391	12732	13265	17985	323	241	39600	180	66000	300	3633	1648	27.46	8.50	2421
819	5.65	7504	10173	10599	14370	323	241	39600	180	66000	300	3633	1928	27.89	8.50	3183
819	5.65	9391	12732	13265	17985	323	241	39600	180	66000	300	4251	1928	27.89	8.50	2543
983	6.78	9867	13377	13937	18895	516	385	48400	220	79200	330	4251	3020	27.89	10.70	3183
656	4.52	9294	12600	13127	17797	344	257	48400	220	79200	330	6658	2457	35.10	8.70	3344
983	6.78	13941	18900	19691	26696	516	385	48400	220	79200	330	5417	3020	28.54	10.70	3150
656	4.52	12954	17562	18297	24806	344	257	48400	220	79200	330	6658	2457	35.10	8.70	4725
819	5.65	13044	17684	18424	24978	430	321	48400	220	79200	330	5417	2757	28.54	9.70	4390
983	6.78	15652	21221	22109	29974	516	385	48400	220	79200	330	6078	3020	31.82	10.70	4421
590	4.07	10751	14576	15186	20589	387	289	66000	300	123750	550	6658	3445	35.10	9.80	5305

TIANHE Integral Blade Stabilizer (IBS) is a one piece rotating stabilizer which can be placed near bit or higher in the drill string. It is a one piece construction manufactured from high strength alloy steel (non-magnet steel optional), that prevents differential sticking of the drillstring by stabilizing the BHA and keeping drill collars and drill pipes away from the borehole wall. This reduces vibration, drill pipe whirl, and wellbore tortuosity; furthermore, the stabilization maintains drilling trajectory whether drilling straight, horizontal, or directional wells.

## Optional Stabilizers

TIANHE offers several options for IBS, in both alloy steel and non-magnet materials:

- Spiral Integral Blade Stabilizer;
- Straight Integral Blade Stabilizer;
- non-Magnet Integral Blade Stabilizer;

## When ordering please specify:

- Hole size or required blade O.D.;
- Number of blades required (3 or 4 are standard styles);
- Straight or spiral blades;
- Hardfacing type;
- Top and bottom connections;
- Body diameter required;
- String or near bit application;
- Alloy steel or non-magnet materials;
- Special features SRG on connections, bored for float etc.

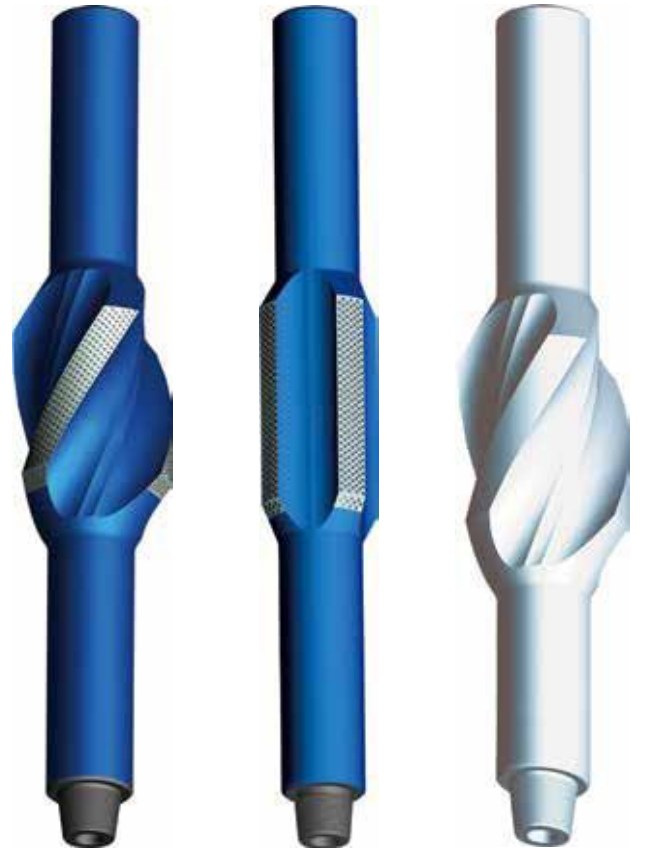

Spiral Integral Blade Stabilizer (W01)

Straight Integral Blade Stabilizer (W04)

non-Magnet Integral Blade Stabilizer (W17)

## Specifications - Spiral Integral Blade Stabilizer

Product Code					OD stab	Body OD	ID	Fishing neck length	Crown length	Blade taper angle		Overall length	Top connection	Bottom connection
HF1000	HF2000	HF3000	HF4000	HF5000						Top	Bottom			
W0113701	W0123701	W0133701	W0143701	W0153701	3 3/4" 95.3mm	3 1/8" 79.4mm	1 1/4" 31.8mm	26" 660mm	10" 254mm	30°	15°	58" 1480m m	NC23 B	NC23 P
W0113702	W0123702	W0133702	W0143702	W0153702	3 3/4" 95.3mm	3 1/8" 79.4mm	1 1/4" 31.8mm	26" 660mm	10" 254mm	30°	15°	58" 1480m m	NC23 B	2 3/8REG B
W0114501	W0124501	W0134501	W0144501	W0154501	4 1/2" 114.3mm	3 1/2" 88.9mm	1 1/2" 38.1mm	26" 660mm	10" 254mm	30°	15°	59" 1500m m	NC26 B	NC26 P
W0114502	W0124502	W0134502	W0144502	W0154502	4 1/2" 114.3mm	3 1/2" 88.9mm	1 1/2" 38.1mm	26" 660mm	10" 254mm	30°	15°	59" 1500m m	NC26 B	2 3/8REG B
W0115501	W0125501	W0135501	W0145501	W0155501	5 1/2" 139.7mm	4 3/4" 120.6mm	2 " 50.8mm	30" 762mm	12" 305mm	30°	15°	68" 1730m m	NC38 B	NC38 P
W0115502	W0125502	W0135502	W0145502	W0155502	5 1/2" 139.7mm	4 3/4" 120.6mm	2 " 50.8mm	30" 762mm	12" 305mm	30°	15°	68" 1730m m	NC38 B	3 1/2REG B
W0110301	W0120301	W0130301	W0140301	W0150301	6" 152.4mm	4 3/4" 120.6mm	2" 50.8mm	30" 762mm	12" 305mm	30°	15°	69" 1760m m	NC38 B	NC38 P
W0110302	W0120302	W0130302	W0140302	W0150302	6" 152.4mm	4 3/4" 120.6mm	2" 50.8mm	30" 762mm	12" 305mm	30°	15°	69" 1760m m	NC38 B	3 1/2REG B
W0110701	W0120701	W0130701	W0140701	W0150701	7 1/2" 190.5mm	6 1/2" 165.1mm	2 13/16 " 71.4mm	30" 762mm	16" 406mm	30°	30°	72" 1830m m	NC46 B	NC46 P
W0110702	W0120702	W0130702	W0140702	W0150702	7 1/2" 190.5mm	6 1/2" 165.1mm	2 13/16 " 71.4mm	30" 762mm	16" 406mm	30°	30°	72" 1830m m	NC46 B	4 1/2REG B
W0110801	W0120801	W0130801	W0140801	W0150801	7 7/8" 200mm	6 1/2" 165.1mm	2 13/16 " 71.4mm	30" 762mm	16" 406mm	30°	30°	72" 1830m m	NC46 B	NC46 P

## Specifications - Spiral Integral Blade Stabilizer

Product Code					OD stab	Body OD	ID	Fishing neck length	Crown length	Blade taper angle		Overall length	Top connection	Bottom connection
HF1000	HF2000	HF3000	HF4000	HF5000						Top	Bottom			
W0110802	W0120802	W0130802	W0140802	W0150802	7 7/8" 200mm	6 1/2" 165.1mm	2 13/16" 71.4mm	30" 762mm	16" 406mm	30°	30°	72" 1830mm	NC46 B	4 1/2REG B
W0110803	W0120803	W0130803	W0140803	W0150803	8" 203.2mm	6 3/4" 171mm	2 13/16" 71.4mm	30" 762mm	16" 406mm	30°	30°	73" 1860mm	NC50 B	NC50 P
W0110804	W0120804	W0130804	W0140804	W0150804	8" 203.2mm	6 3/4" 171mm	2 13/16" 71.4mm	30" 762mm	16" 406mm	30°	30°	73" 1860mm	NC50 B	4 1/2REG B
W0111101	W0121101	W0131101	W0141101	W0151101	8 1/2" 215mm	6 3/4" 171mm	2 13/16" 71.4mm	30" 762mm	16" 406mm	30°	30°	73" 1860mm	NC50 B	NC50 P
W0111102	W0121102	W0131102	W0141102	W0151102	8 1/2" 215mm	6 3/4" 171mm	2 13/16" 71.4mm	30" 762mm	16" 406mm	30°	30°	73" 1860mm	NC50 B	4 1/2REG B
W0111401	W0121401	W0131401	W0141401	W0151401	9 1/2" 241.3mm	6 3/4" 171mm	2 13/16" 71.4mm	30" 762mm	16" 406mm	30°	30°	75" 1900mm	NC50 B	NC50 P
W0111402	W0121402	W0131402	W0141402	W0151402	9 1/2" 241.3mm	6 3/4" 171mm	2 13/16" 71.4mm	30" 762mm	16" 406mm	30°	30°	75" 1900mm	NC50 B	4 1/2REG B
W0112001	W0122001	W0132001	W0142001	W0152001	12" 304.8mm	8" 203.2mm	2 13/16" 71.4mm	30" 762mm	18" 457mm	30°	30°	79" 2010mm	6 5/8REG B	6 5/8REG P
W0112002	W0122002	W0132002	W0142002	W0152002	12" 304.8mm	8" 203.2mm	2 13/16" 71.4mm	30" 762mm	18" 457mm	30°	30°	79" 2010mm	6 5/8REG B	6 5/8REG B
W0112101	W0122101	W0132101	W0142101	W0152101	12 1/4" 311mm	8" 203.2mm	2 13/16" 71.4mm	30" 762mm	18" 457mm	30°	30°	79" 2010mm	6 5/8REG B	6 5/8REG P
W0112102	W0122102	W0132102	W0142102	W0152102	12 1/4" 311mm	8" 203.2mm	2 13/16" 71.4mm	30" 762mm	18" 457mm	30°	30°	79" 2010mm	6 5/8REG B	6 5/8REG B
W0112201	W0122201	W0132201	W0142201	W0152201	14 3/4" 374mm	8" 203.2mm	2 13/16" 71.4mm	30" 762mm	18" 457mm	30°	30°	84" 2140mm	6 5/8REG B	6 5/8REG P
W0112202	W0122202	W0132202	W0142202	W0152202	14 3/4" 374mm	8" 203.2mm	2 13/16" 71.4mm	30" 762mm	18" 457mm	30°	30°	84" 2140mm	6 5/8REG B	6 5/8REG B
W0112203	W0122203	W0132203	W0142203	W0152203	15 1/2" 393.7mm	8" 203.3mm	2 13/16" 71.4mm	30" 762mm	18" 457mm	30°	30°	85" 2160mm	6 5/8REG B	6 5/8REG P
W0112204	W0122204	W0132204	W0142204	W0152204	15 1/2" 393.7mm	8" 203.3mm	2 13/16" 71.4mm	30" 762mm	18" 457mm	30°	30°	85" 2160mm	6 5/8REG B	6 5/8REG B
W0112301	W0122301	W0132301	W0142301	W0152301	16" 406.4mm	9 1/2" 241.3mm	3" 76.2mm	30" 762mm	20" 508mm	30°	30°	85" 2160mm	7 5/8REG B	7 5/8REG P
W0112302	W0122302	W0132302	W0142302	W0152302	16" 406.4mm	9 1/2" 241.3mm	3" 76.2mm	30" 762mm	20" 508mm	30°	30°	85" 2160mm	7 5/8REG B	7 5/8REG B
W0112401	W0122401	W0132401	W0142401	W0152401	17" 431.8mm	9 1/2" 241.3mm	3" 76.2mm	30" 762mm	20" 508mm	30°	30°	88" 2240mm	7 5/8REG B	7 5/8REG P
W0112402	W0122402	W0132402	W0142402	W0152402	17" 431.8mm	9 1/2" 241.3mm	3"v 76.2mm	30" 762mm	20" 508mm	30°	30°	88" 2240mm	7 5/8REG B	7 5/8REG B
W0112501	W0122501	W0132501	W0142501	W0152501	17 1/2" 444mm	9 1/2" 241.3mm	3" 76.2mm	30" 762mm	20" 508mm	30°	30°	88" 2240mm	7 5/8REG B	7 5/8REG P
W0112502	W0122502	W0132502	W0142502	W0152502	17 1/2" 444mm	9 1/2" 241.3mm	3" 76.2mm	30" 762mm	20" 508mm	30°	30°	88" 2240mm	7 5/8REG B	7 5/8REG B
W0112601	W0122601	W0132601	W0142601	W0152601	20" 508mm	9 1/2" 241.3mm	3" 76.2mm	30" 762mm	20" 508mm	30°	30°	92" 2340mm	7 5/8REG B	7 5/8REG P
W0112602	W0122602	W0132602	W0142602	W0152602	20" 508mm	9 1/2" 241.3mm	3" 76.2mm	30" 762mm	20" 508mm	30°	30°	92" 2340mm	7 5/8REG B	7 5/8REG B
W0112701	W0122701	W0132701	W0142701	W0152701	22" 558.8mm	9 1/2" 241.3mm	3" 76.2mm	30" 762mm	20" 508mm	35°	35°	92" 2340mm	7 5/8REG B	7 5/8REG P
W0112702	W0122702	W0132702	W0142702	W0152702	22" 558.8mm	9 1/2" 241.3mm	3" 76.2mm	30" 762mm	20" 508mm	35°	35°	92" 2340mm	7 5/8REG B	7 5/8REG B
W0112801	W0122801	W0132801	W0142801	W0152801	24" 609.6mm	9 1/2" 241.3mm	3" 76.2mm	32" 813mm	20" 508mm	45°	45°	97" 2460mm	7 5/8REG B	7 5/8REG P
W0112802	W0122802	W0132802	W0142802	W0152802	24" 609.6mm	9 1/2" 241.3mm	3" 76.2mm	32" 813mm	20" 508mm	45°	45°	97" 2460mm	7 5/8REG B	7 5/8REG B
W0112901	W0122901	W0132901	W0142901	W0152901	26" 660mm	9 1/2" 241.3mm	3" 76.2mm	32" 813mm	20" 508mm	45°	45°	100" 2540mm	7 5/8REG B	7 5/8REG P
W0112902	W0122902	W0132902	W0142902	W0152902	26" 660mm	9 1/2" 241.3mm	3" 76.2mm	32" 813mm	20" 508mm	45°	45°	100" 2540mm	7 5/8REG B	7 5/8REG B
W0113401	W0123401	W0133401	W0143401	W0153401	28" 711mm	9 1/2" 241.3mm	3" 76.2mm	32" 813mm	20" 508mm	45°	45°	102" 2590mm	7 5/8REG B	7 5/8REG P
W0113402	W0123402	W0133402	W0143402	W0153402	28" 711mm	9 1/2" 241.3mm	3" 76.2mm	32" 813mm	20" 508mm	45°	45°	102" 2590mm	7 5/8REG B	7 5/8REG B
W0113001	W0123001	W0133001	W0143001	W0153001	30" 762mm	9 1/2" 241.3mm	3" 76.2mm	34" 864mm	20" 508mm	45°	45°	107" 2720mm	7 5/8REG B	7 5/8REG P
W0113002	W0123002	W0133002	W0143002	W0153002	30" 762mm	9 1/2" 241.3mm	3" 76.2mm	34" 864mm	20" 508mm	45°	45°	107" 2720mm	7 5/8REG B	7 5/8REG B
W0113101	W0123101	W0133101	W0143101	W0153101	36" 914mm	9 1/2" 241.3mm	3" 76.2mm	36" 914mm	20" 508mm	45°	45°	120" 3050mm	7 5/8REG B	7 5/8REG P
W0113102	W0123102	W0133102	W0143102	W0153102	36" 914mm	9 1/2" 241.3mm	3" 76.2mm	36" 914mm	20" 508mm	45°	45°	120" 3050mm	7 5/8REG B	7 5/8REG B

## Specifications - Straight Integral Blade Stabilizer

Product Code					OD stab	Body OD	ID	Fishing neck length	Crown length	Blade taper angle		Overall Length	Thread connection	
HF1000	HF2000	HF3000	HF4000	HF5000						Top	Bottom		Top	Bottom
W0410301	W0420301	W0430301	W0440301	W0450301	6" 152.4mm	4 3/4" 120.6mm	2 " 50.8mm	30" 762mm	12" 305mm	30°	15°	69" 1760mm	NC38 B	NC38 P
W0410302	W0420302	W0430302	W0440302	W0450302	6" 152.4mm	4 3/4" 120.6mm	2 " 50.8mm	30" 762mm	12" 305mm	30°	15°	69" 1760mm	NC38 B	3 1/2 REG B
W0410701	W0420701	W0430701	W0440701	W0450701	7 1/2" 190.5mm	6 1/2" 165.1mm	2 13/16 " 71.4mm	30" 762mm	16" 406mm	30°	30°	72" 1830mm	NC46 B	NC46 P
W0410702	W0420702	W0430702	W0440702	W0450702	7 1/2" 190.5mm	6 1/2" 165.1mm	2 13/16 " 71.4mm	30" 762mm	16" 406mm	30°	30°	72" 1830mm	NC46 B	4 1/2 REG B
W0410801	W0420801	W0430801	W0440801	W0450801	7 7/8" 200mm	6 1/2" 165.1mm	2 13/16 " 71.4mm	30" 762mm	16" 406mm	30°	30°	72" 1830mm	NC46 B	NC46 P
W0410802	W0420802	W0430802	W0440802	W0450802	7 7/8" 200mm	6 1/2" 165.1mm	2 13/16 " 71.4mm	30" 762mm	16" 406mm	30°	30°	72" 1830mm	NC46 B	4 1/2 REG B
W0410803	W0420803	W0430803	W0440803	W0450803	8" 203.2mm	6 3/4" 171mm	2 13/16 " 71.4mm	30" 762mm	16" 406mm	30°	30°	73" 1860mm	NC50 B	NC50 P
W0410804	W0420804	W0430804	W0440804	W0450804	8" 203.2mm	6 3/4" 171mm	2 13/16 " 71.4mm	30" 762mm	16" 406mm	30°	30°	73" 1860mm	NC50 B	4 1/2 REG B
W0411101	W0421101	W0431101	W0441101	W0451101	8 1/2" 215mm	6 3/4" 171mm	2 13/16 " 71.4mm	30" 762mm	16" 406mm	30°	30°	73" 1860mm	NC50 B	NC50 P
W0411102	W0421102	W0431102	W0441102	W0451102	8 1/2" 215mm	6 3/4" 171mm	2 13/16 " 71.4mm	30" 762mm	16" 406mm	30°	30°	73" 1860mm	NC50 B	4 1/2 REG B
W0411401	W0421401	W0431401	W0441401	W0451401	9 1/2" 241.3mm	6 3/4" 171mm	2 13/16 " 71.4mm	30" 762mm	16" 406mm	30°	30°	75" 1900mm	NC50 B	NC50 P
W0411402	W0421402	W0431402	W0441402	W0451402	9 1/2" 241.3mm	6 3/4" 171mm	2 13/16 " 71.4mm	30" 762mm	16" 406mm	30°	30°	75" 1900mm	NC50 B	4 1/2 REG B
W0412001	W0422001	W0432001	W0442001	W0452001	12" 304.8mm	8" 203.2mm	2 13/16 " 71.4mm	30" 762mm	18" 457mm	30°	30°	79" 2010mm	6 5/8 REG B	6 5/8 REG P
W0412002	W0422002	W0432002	W0442002	W0452002	12" 304.8mm	8" 203.2mm	2 13/16 " 71.4mm	30" 762mm	18" 457mm	30°	30°	79" 2010mm	6 5/8 REG B	6 5/8 REG B
W0412101	W0422101	W0432101	W0442101	W0452101	12 1/4" 311mm	8" 203.2mm	2 13/16 " 71.4mm	30" 762mm	18" 457mm	30°	30°	79" 2010mm	6 5/8 REG B	6 5/8 REG P
W0412102	W0422102	W0432102	W0442102	W0452102	12 1/4" 311mm	8" 203.2mm	2 13/16 " 71.4mm	30" 762mm	18" 457mm	30°	30°	79" 2010mm	6 5/8 REG B	6 5/8 REG B
W0412201	W0422201	W0432201	W0442201	W0452201	14 3/4" 374mm	8" 203.2mm	2 13/16 " 71.4mm	30" 762mm	18" 457mm	30°	30°	84" 2140mm	6 5/8 REG B	6 5/8 REG P
W0412202	W0422202	W0432202	W0442202	W0452202	14 3/4" 374mm	8" 203.2mm	2 13/16 " 71.4mm	30" 762mm	18" 457mm	30°	30°	84" 2140mm	6 5/8 REG B	6 5/8 REG B
W0412203	W0422203	W0432203	W0442203	W0452203	15 1/2" 393.7mm	8" 203.3mm	2 13/16 " 71.4mm	30" 762mm	18" 457mm	30°	30°	85" 2160mm	6 5/8 REG B	6 5/8 REG P
W0412204	W0422204	W0432204	W0442204	W0452204	15 1/2" 393.7mm	8" 203.3mm	2 13/16 " 71.4mm	30" 762mm	18" 457mm	30°	30°	85" 2160mm	6 5/8 REG B	6 5/8 REG B
W0412301	W0422301	W0432301	W0442301	W0452301	16" 406.4mm	9 1/2" 241.3mm	3 " 76.2mm	30" 762mm	20" 508mm	30°	30°	85" 2160mm	7 5/8 REG B	7 5/8 REG P
W0412302	W0422302	W0432302	W0442302	W0452302	16" 406.4mm	9 1/2" 241.3mm	3 " 76.2mm	30" 762mm	20" 508mm	30°	30°	85" 2160mm	7 5/8 REG B	7 5/8 REG B
W0412401	W0422401	W0432401	W0442401	W0452401	17" 431.8mm	9 1/2" 241.3mm	3 " 76.2mm	30" 762mm	20" 508mm	30°	30°	88" 2240mm	7 5/8 REG B	7 5/8 REG P
W0412402	W0422402	W0432402	W0442402	W0452402	17" 431.8mm	9 1/2" 241.3mm	3 " 76.2mm	30" 762mm	20" 508mm	30°	30°	88" 2240mm	7 5/8 REG B	7 5/8 REG B
W0412501	W0422501	W0432501	W0442501	W0452501	17 1/2" 444mm	9 1/2" 241.3mm	3 " 76.2mm	30" 762mm	20" 508mm	30°	30°	88" 2240mm	7 5/8 REG B	7 5/8 REG P
W0412502	W0422502	W0432502	W0442502	W0452502	17 1/2" 444mm	9 1/2" 241.3mm	3 " 76.2mm	30" 762mm	20" 508mm	30°	30°	88" 2240mm	7 5/8 REG B	7 5/8 REG B
W0412601	W0422601	W0432601	W0442601	W0452601	20" 508mm	9 1/2" 241.3mm	3 " 76.2mm	30" 762mm	20" 508mm	30°	30°	92" 2340mm	7 5/8 REG B	7 5/8 REG P
W0412602	W0422602	W0432602	W0442602	W0452602	20" 508mm	9 1/2" 241.3mm	3 " 76.2mm	30" 762mm	20" 508mm	30°	30°	92" 2340mm	7 5/8 REG B	7 5/8 REG B
W0412701	W0422701	W0432701	W0442701	W0452701	22" 558.8mm	9 1/2" 241.3mm	3 " 76.2mm	30" 762mm	20" 508mm	35°	35°	92" 2340mm	7 5/8 REG B	7 5/8 REG P
W0412702	W0422702	W0432702	W0442702	W0452702	22" 558.8mm	9 1/2" 241.3mm	3 " 76.2mm	30" 762mm	20" 508mm	35°	35°	92" 2340mm	7 5/8 REG B	7 5/8 REG B



TIANHE non-rotating stabilizer (rubber sleeve stabilizer) is able to avoid blade wear and wall damage during drilling. The non-rotating stabilizer consists of mandrel, copper washer, rubber sleeve, spacer sleeve and self-locking lower sub.

During drilling, the non-rotating stabilizer transfers the torque by means of mandrel. The rubber sleeve is sliding and moving relative to the mandrel and it plays a role in stabilizing the well. A locking clutch (self-locking lower sub) will help to avoid sleeve rotation during washover operation.

### When ordering please specify:

- Casing size and weight;
- Hole size or required blade O.D.;
- Top and bottom connections.



Non-Rotating  
Stabilizer  
(W09)

### Specifications - Non-Rotating Stabilizer

Sleeve			Mandrel			overall Length (mm)	Product Code
Length (mm)	O. D. (mm)	Blade Qty	I. D. (mm)	Fishing O. D. (mm)	Connection		
380	Φ155	4	Φ44	Φ121	NC38	1638	W0900301
380	Φ157	4	Φ44	Φ127	NC38	1638	W0900401
500	Φ214	4	Φ71	Φ165	NC50	2013	W0901001
500	Φ220	4	Φ71	Φ165	NC50	2013	W0901201
500	Φ255	4	Φ71	Φ165	NC50	2013	W0901601
500	Φ304	4	Φ76	Φ203	6 5/8 REG	2000	W0902001
500	Φ310	4	Φ76	Φ203	6 5/8 REG	2000	W0902101
500	Φ313	4	Φ71	Φ165	NC50	2013	W0902103
500	Φ371	4	Φ71	Φ197	6 5/8 REG	2013	W0902201
500	Φ374	4	Φ71	Φ203	6 5/8 REG	2013	W0902203
520	Φ405	4	Φ76	Φ241	7 5/8 REG	2045	W0902301
520	Φ430	4	Φ76	Φ241	7 5/8 REG	2045	W0902401
520	Φ444	4	Φ76	Φ241	7 5/8 REG	2045	W0902501
600	Φ558	4	Φ76	Φ241	7 5/8 REG	2130	W0902701
690	Φ711	5	Φ76	Φ241	7 5/8 REG	2210	W0903401

TIANHE replaceable sleeve stabilizer consists of an integral mandrel and a sleeve. One mandrel series can be equipped with different sizes of sleeve for several hole sizes. In order to match the drilling conditions, the sleeves can be easily changed on the rig floor during changing of hole size or wear surface.

### When ordering please specify:

- Mandrel series and sleeve O.D.;
- String or near bit application;
- Top and bottom connection;
- Hard facing type.



Replaceable Sleeve Stabilizer (W05)

### Specifications - Replaceable Sleeve Stabilizer

Product Code					Hole Size (in)	Mandrel Series	Sleeve		Body				Connection	
HF1000	HF2000	HF3000	HF4000	HF5000			Body Diameter (in)	Sleeve Length (in)	Fishing Neck Range	Upset O.D (in)	Bottom Neck O.D	Overall Length (in)		Fishing Neck Length
W0511100	W0521100	W0531100	W0541100	W0551100	8 1/2	62	7 1/2	19	6 3/4	7 1/2	6 1/4	65	22	NC50
W0512100	W0522100	W0532100	W0542100	W0552100	12 1/4	77	9 1/2	20	8	9 1/4	7 3/4	70	22	6 5/8 REG
W0512300	W0522300	W0532300	W0542300	W0552300	16	96	11 1/2	24	9 1/2	11	9	82 3/4	27	7 5/8 REG
W0512500	W0522500	W0532500	W0542500	W0552500	17 1/2	96	11 1/2	24	9 1/2	11	9	82 3/4	27	7 5/8 REG
W0512700	W0522700	W0532700	W0542700	W0552700	22	96	14 1/4	27.5	9 1/2	11	9	82.75	27	7 5/8 REG
W0512800	W0522800	W0532800	W0542800	W0552800	24	96	14 1/4	27.5	9 1/2	11	9	82.75	27	7 5/8 REG
W0512900	W0522900	W0532900	W0542900	W0552900	26	96	17	27.5	9 1/2	11	9	82.75	27	7 5/8 REG
W0513400	W0523400	W0533400	W0543400	W0553400	28	96	17 1/4	27.5	9 1/2	11	9	82.75	27	7 5/8 REG

We offer a complete range of Hardfacing to suit all drilling conditions. All TIANHE Stabilizers can be banded with the following hardfacings.



Crushed tungsten carbide held in a nickel bronze matrix. The 3mm grain size ensures greater concentration of carbide which is ideal for soft formation drilling.



Trapezoidal tungsten carbide inserts held in a sintered carbide nickel bronze matrix. This will give a greater depth of carbide coverage – ideal for high deviation drilling in abrasive formations.



Tungsten carbide inserts set in a powder spray deposit ideal for abrasive formations. 97% bonding guaranteed, certified by ultrasonic report. Recommended for non-magnetic stabilizers.



Tungsten carbide inserts (button type). The inserts have been developed to allow cold insertion and maintain close fit. A greater concentration of inserts on the bottom third of the blade and leading edge will increase surface contact to reduce wear in highly abrasive formations.



This oxy-acetylene process applies tough molten carbide particles of varying sizes held in a nickel chrome matrix which provides excellent bonding properties and greater surface wear characteristics are achieved. Surface hardness levels over 40 HRC. Ideal for GEO-THERMAL applications over 350°



This process is a highly automated way of applying hardface and utilizes a combined arc/plasma stream on the work piece surface. This results a low base metal dilution and a dense, uniform coating, the filling medium can be variety of hardfacing consumables.

TIANHE Fixed Diameter Hole Openers are designed for use in soft clays and shales to medium-hard shales and limestones. It is particularly effective in sticky formations where balling problems are encountered. Three jets with replaceable nozzles continuously clean the tool's cutting structure, clearing debris buildup and increasing penetration.

Fixed Diameter Hole Openers are used in the following conditions:

1. When drilling of a big hole is not possible because of rig capacity.
2. When a satisfied penetration rate is not obtained when drilling a big hole, it is used after drilling is completed with a smaller bit.
3. When the hole direction must be controlled.

### When ordering please specify:

- Hole size;
- Pilot hole size;
- Top and bottom connections;
- Fishing neck and bottom neck O.D and length;
- Type of cutters.



Type SM  
Tooth Type For Soft  
To Medium  
Formations



Type MH  
Tooth Type For Medium  
To Hard Formations



Type XH Conical  
Button Type For Hard  
Formations



Fixed Diameter Hole  
Opener  
(KL)

### Specifications - Fixed Diameter Hole Opener

Model	Product Code	Hole Open Diameter	Qty Of Cutters	Min.Pilot Hole	Fishing Neck Diameter	ID.	Top Connection (Pin)	Bottom Connection (Box)	Overall Length
KKQ209	KL09000	8 1/4"	3	5 1/2"	6 1/2"	1 1/4"	NC46	3 1/2 REG	55"
KKQ216	KL10000	8 1/2"	3	5 1/2"	6 1/2"	1 1/4"	NC46	3 1/2 REG	55"
KKQ311	KL01000	12 1/4"	3	8 1/2"	8"	1 1/2"	6 5/8 REG	6 5/8 REG	55"
KKQ406	KL02000	16"	3	10"	9 1/2"	2 1/4"	7 5/8 REG	6 5/8 REG	59"
KKQ444	KL03000	17 1/2"	3	10 1/2"	9 1/2"	2 1/4"	7 5/8 REG	6 5/8 REG	59"
KKQ559	KL04000	22"	3	12 3/4"	9 1/2"	2 1/4"	7 5/8 REG	6 5/8 REG	69"
KKQ584	KL05000	23"	3	12 3/4"	10"	3"	7 5/8 REG	6 5/8 REG	69"
KKQ610	KL06000	24"	3	14"	10"	3"	7 5/8 REG	7 5/8 REG	69"
KKQ660	KL07000	26"	3	17 1/2"	10"	3"	7 5/8 REG	7 5/8 REG	69"
KKQ813	KL11000	32"	3	17 1/2"	10"	3"	7 5/8 REG	7 5/8 REG	79"
KKQ4-914	KL08000	36"	4	26"	10"	3 1/2"	7 5/8 REG	7 5/8 REG	87"

Roller Reamers are designed for reaming and stabilization in any type of formation. All parts of the tool are made of special alloy steel and heat treated for hardness. Drilling crews can easily replace any part in the field without using any special tools.

TIANHE offers three types of cutters for different type of formation.

### When ordering please specify:

- Hole size;
- String type or near bit type;
- Drill collar size;
- Top and bottom connection;
- Type of cutters.



Type B  
Hard Formations



Type F  
Medium to Hard Formations



Type T  
Soft Formations



Roller Reamer  
(W16)

### Specifications - Roller Reamer

Model	Product Code	O.D (mm)	I.D. (mm)	Connection	Hole Size (in)
WG155	W1104100	155	25.4	NC38	6 1/8
WG200	W1110100	200	38	NC46	7 7/8
WG212	W1111200	212	44	NC50	8 3/8
WG215	W1113100	215	44	NC50	8 1/2
WG244	W1114100	244	57	NC50	9 5/8
WG311	W1121100	311	71	6 5/8 REG	12 1/4
WG444	W1128100	444	76	7 5/8 REG	17 1/2
WG558	W1131100	558	76	7 5/8 REG	22
WG660	W1133100	660	76	7 5/8 REG	26
WG711	W1134100	711	76	7 5/8 REG	28
WG914	W1137100	914	76	7 5/8 REG	36



During drilling, fishing, completion or wireline jobs, it is critical for the downhole tools to have a obstruction-free casing so as to increase efficiency. Casing Scraper removes rust, scale, cement, mud, bullets, paraffin, perforation burrs and other obstructions or foreign material from the inside walls of casing.

Maintaining a clean casing is important during drilling operation, fishing or wireline tools. Likewise, packers, patches, spears, and similar tools require clean surfaces to grip. Obstructions on casing walls frequently cause these tools to fail or become difficult to operate.

Our Casing Scraper removes deposits, burrs, and irregularities from casing that might cause trouble during the operation of packers or other close tolerance equipment.

Casing Scraper has two sets of blades. Each blade is constructed using high quality cast steel for excellent scraping characteristics and long-lasting durability. These scraper blades are designed to scrape over 360° of surface area. The scraper blades are designed with a long taper for passing through casing connections with minimal chance of hanging up.

## Operation

The Casing Scraper is normally connected to the work string with a drill bit attached at the bottom. Simply run the scraper into the casing or tubing using rotation or spudding to clean the inside wall of the pipe.

## When ordering please specify:

- Casing Scraper model;
- Connection, if non-standard;
- Casing size and weight.

## Specifications - Casing Scraper

Model	Applicable casing size (lb/ft)	OD of body (mm)	Max. OD of cutter stretch out-Min. OD of cutter stretch out (mm)	ID (mm)	Connection	Product Code
GX102	4 "(9.26~13.2)	80	92~81.4	16	2 3/8REG	X01-14010
GX114	4 1/2"(9.5~15.1)	90.5	106~92	20	2 3/8REG	X01-01010
GX114A	4 1/2"(13.5-18.8)	89	102~89	20	2 3/8REG	X01-01030
GX127	5"(11.5~18)	100	118~102	20	2 3/8REG	X01-02010
GX127A	5"(11.5~24.1)	92	118~96.3	18	2 3/8REG	X01-02030
GX140	5 1/2"(14~23)	110	130~114	24	2 7/8REG	X01-03010
GX140A	5 1/2"(17~26.8)	106	127~107.7	24	2 7/8REG	X01-03030
GX146	5 3/4"(14-25.2)	110	138~118	24	2 7/8REG	X01-04010
GX168	6 5/8"(17-34)	130	158~137	24	3 1/2REG	X01-05010
GX178	7"(17~38)	136	168~146	30	3 1/2REG	X01-06010
GX178B	7"(13~40)	136	170.8~143.4	30	3 1/2REG	X01-06030
GX194A	7 5/8"(24~45.3)	136	182~159	30	3 1/2REG	X01-07010
GX219	8 5/8"(24~52)	175	208~183	30	4 1/2REG	X01-08010
GX245	9 5/8"(32.3~61.1)	200	232~207	57	4 1/2REG	X01-09010
GX273	10 3/4"(32.75~71.1)	228	262~235	57	6 5/8REG	X01-10010
GX298	11 3/4" (38~87.2)	250	287~255	71	6 5/8REG	X01-15010
GX340	13 3/8"(48~88.2)	286	326~301	71	6 5/8REG	X01-11010
GX473	18 5/8"(73.09~122)	420	460~432	76	7 5/8REG	X01-12010
GX508	20"(84.75~133)	443	493~467	76	7 5/8REG	X01-13010



Casing Scraper (X01)

The key seat reamer is a sleeve with five blades dressed with an aggressive tungsten carbide hardfacing. Key Seat Wipers are most effective for reaming out key seats when pulling out of the hole using the single-clutch ascent type, or using the double-clutch dual-action ascent-descent type when reaming in and out of the hole.

Running TIANHE key seat reamer will save you from costly fishing jobs and downtime.

### OPERATION AND APPLICATION

The key seat reamer is placed in the string between the drill pipe and the drill collars. During drill ahead operations, the non-rotating sleeve will not ream the formation. In case of over-pull -- when tripping out drill collars or reaming back to shoe through a dogleg -- rotate the drillstring while pulling out of hole to cause the clutch ring to transmit rotation to the wiper sleeve and initiate reaming operations.

The reamer blades will enlarge the key seat to allow the passage of the bottom hole assembly through potential tight sections of the hole.

#### When ordering please specify:

- Upper and lower neck diameter;
- Upper and lower connections;
- Circulation bore;
- Drill collar O.D. or gauge O.D. of wiper sleeve at blades



key seat reamer  
(JK)

### Specifications - Key Seat Wiper

Model	Product Code	O.D. of sub(mm)	O.D. of blade (mm)	I.D. (mm)	Sliding sleeve stroke L (mm)	Connection	Max .work temperature (°C )
JKQ121	JK12100	115	121	38	317	NC31	<200
JKQ178	JK17800	165	178	70	325	NC50	<200
JKQ203	JK20300	188	203	70	325	NC50	<200
JKQ207	JK20700	188	207	70	325	NC50	<200

Rotary Subs are made from AISI 4145H modified quenched and tempered material. In addition, it is designed and manufactured according to API specifications as well as with API monogram. They can be used to crossover from connection size to another or as a disposable component used to extend the connection life of a more expensive drill stem member.

### Lift Sub

A lift Sub enables safe and efficient handling of straight OD tubulars such as drill collars, shock tools, jars, directional equipment and other tools by using the drill pipe elevators.

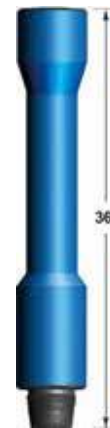

Lift Sub



Saver Sub

### Saver Sub

When rods is added to increase the depth of drilling, the loosening of the threads are now performed at the bottom end of the Saver Sub as opposed to the bottom of the Kelly which is the most valuable part of the drill string. This means that the connection between the top end of the Saver sub and Kelly is seldom used, and suffers minimal wear and tear, whereas the lower connection is used in almost all cases displacing the most wear and tear from the rotary head connection to the much cheaper Saver Sub which is expendable and reduce cost.

### Straight OD Sub

Straight OD Sub is used to connect drill stem members that have a similar outside diameter. The drill bit, downhole tools, heavy weight drill pipe and drill pipe can be crossed over using a straight OD sub.



Straight OD Subs

### Reduced Section Sub

Reduced Section Sub is used to connect drill stem parts that have different diameters. This sub can be used to crossover large OD drilling tools or a tapered drill collar string.

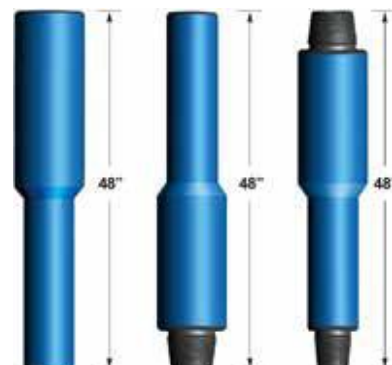

Reduced Section Subs

The oriented bent sub is a major power deflection tool having a fixed angle deviated from the low end thread of the bent sub to the axial line of drill stem. Under the application of oriented bent sub the power drill tool give the bit a constant lateral force to ensure that the bit can cut on the well wall laterally and further drill into a curved well trace.

## Operation method

- After the bit and oriented sub are connected and screwed, measuring of the angle between the nozzle of bit and oriented key of oriented bent sub shall be done;
- After run in drill tool, calculate out the azimuth of nozzle of bit according to the azimuth of oriented key determined at a single point by drift indicator;
- Change the nozzle of the bit into required azimuth, then lock in rotary and start pump drilling to cut in;
- During deflecting, using this approach that deflects while lightly pressing and crowning the drill to help deflection;
- After deflected for 2 to 3 meters, drill in 4 to 5 meters with light pressure and slow rotation;
- Repeat above mentioned operations for several times, when the angle of deviation is up to the expected requirement deflecting in can be done smoothly by reducing drill pressure and increasing rotation speed.



Oriented  
Bent Sub  
(J08)

## Specifications - Oriented Bent Sub

Model	Product Code	O. D.mm (in)	Connection		Bent Angle (Degree)	I. D. of Oriented Sleeve (mm)
			Box	Pin		
DZT89	J0802010	89 (3 1/2)	NC26	NC26	2°	36
DZT105	J0804010	105 (4 1/8)	NC31	NC31	2°	36
DZT127	J0807010	127 (5)	NC38	NC38	2°	36
DZT159	J0808010	159 (6 1/4)	NC46	NC46	2°	50
DZT165	J0809010	165 (6 1/2)	NC50	NC50	2°	50
DZT178	J0812010	178 (7)	5 1/2 FH	5 1/2 FH	2°	50
DZT203	J0814010	203 (8)	6 5/8 REG	6 5/8 REG	2°	50

The Circulating Sub is connected between wellhead pipe string and ground circulating system. When casing is running or completed, the circulating sub can be connected to provide fluid circulation.

According to the application, circulating sub is connected between Kelly and casing or between casing and a hose.

## Construction

The circulating sub during running casing is equipped with casing pin thread on one end and DP thread, DP box thread or union thread on the other.



Circulating Sub With Drill Pipe Thread (J03)



Circulating Sub With Hammer Union Thread (J04)

## Specifications - Circulating Sub With Drill Pipe Thread

Thread/ Model			I. D. (mm)	Length (mm)
Drill pipe box connection	Casing thread	Product Code		
NC38	5 BTC	J030701	57	580
	5 LTC	J030702		
	5 STC	J030703		
NC38	5 1/2 BTC	J030801	57	580
	5 1/2 LTC	J030802		
	5 1/2 STC	J030803		
NC50	7 BTC	J031201	71	610
	7 LTC	J031202		
	7 STC	J031203		
NC50	9 5/8 BTC	J031801	71	610
	9 5/8 LTC	J031802		
	9 5/8 STC	J031803		
NC50	10 3/4 BTC	J031901	71	610
	10 3/4 STC	J031902		
NC50	13 3/8 BTC	J032001	71	650
	13 3/8 STC	J032002		

## Specifications - Circulating Sub With Hammer union Thread

Thread/ Model			I. D. (mm)	Length (mm)
Drill pipe Box connection	Casing thread	Product Code		
2"1502 Union	5 BTC	J040701	50.8	500
2"1502 Union	5 1/2 BTC	J040801	50.8	500
2"1502 Union	7 BTC	J041201	50.8	500
	7 LTC	J041202		
2"1502 Union	9 5/8 BTC	J041801	50.8	500
	9 5/8 LTC	J041802		
2"1502 Union	10 3/4 BTC	J041901	50.8	560
	10 3/4 STC	J041902		
2"1502 Union	13 3/8 BTC	J042001	50.8	610
	13 3/8 STC	J042002		



During drilling operation, major wear and tear wear often take place between drill pipes and casings. Wear Sub is used to avoid the wear between drill pipes, tool joints and casings. With features such as compact structure and easy operating, Wear sub can prolong the service life of drill pipe and casing and reduce the vibration and trembling of drilling tools. It can also limit the contact friction between metals.

TIANHE wear sub consists of a highly wear rubber sleeve, a metal stiffening liner and a sub body. The rubber sleeve is installed in the middle of sub body and some clearance is given to allow sleeve to rotate freely. The rubber sleeves are made of rubber mixtures with good wear resistance.

During drilling operation, the rubber sleeve and sub body can make a relative rotation. The rubber sleeve O.D is larger than drill pipe tool joint O.D, therefore the tool joint and drill pipes cannot come in contact with casing. The rubber sleeve on saver sub will first contact with casing. When friction between rubber sleeve and casing takes place, wearing can be reduced due to the rubber sleeve wear resistance and softness. Usage of tool joints of drill pipes and drill string tools will also be reduced.

#### When ordering please specify:

- Casing size and weight, or O.D of wear sub;
- Connection.



Wear Sub  
(J14)

#### Specifications - Wear Sub

Specification	Body O.D.(mm)	Sub O.D.(mm)	I.D.(mm)	Connection	Product Code
7" Casing	121	143	38.1	3 1/2 IF	J1408010
9 5/8" Casing	168	190	71.4	4 1/2 IF	J1413010
	178	197	71.4	5 1/2 FH	J1413020
10 3/4" Casing	180	225	71.4	4 1/2 IF	J1417010
				5 1/2 FH	J1417020
13 3/8" Casing	203	285	71.4	5 1/2 FH	J1420010

Drift is a simple and popular tool for drifting I.D. of casing, tubing, drill pipe and other pipes. It is used to check whether inside diameter of all kinds of pipes are complied with standard, and to determine the max. inside diameter to be drifted after deformation. The drift is thus granted as a necessary tool in workover operation.

### Drift for casings are available in two types:

Sub Type Drift manufactured with threads on both top and bottom ends. The top end is connected with the drill string, while the bottom end is standby.

Bail Type Drift comprises of gauge plate and connecting rod.

Double Bail Drift for tubing or drill pipe is usually used on the ground. The shape of drift diameter gauge is a long cylindrical body with sucker rod thread on both ends. Drifting is done manually.



Bail Type Casing Drift

Double Bail Drift

Sub Type Drift

### Casing Drift (Sub Type Drift )

Casing Size(in)	Product Code	O.D. (mm)	Length (mm)	up connection	Bottom Connection
4 1/2	X021140A	92~95	500	NC26	NC26
5	X021270A	102~107	500	NC26	NC26
5 1/2	X021400A	114~118	500	NC31	NC31
5 3/4	X021460A	119~128	500	NC31	NC31
6 5/8	X021680A	136~148	500	NC31	NC31
7	X021780A	146~158	500	NC38	NC38

### Casing Drift (Bail Type Drift )

Size (in)	Product code	Length (mm)	Max. O. D. (mm)
4 1/2	X021140A0	152	d-3.18
5	X021270A0	152	d-3.18
5 1/2	X021400A0	152	d-3.18
6 5/8	X021680A0	152	d-3.18
7	X021780A0	152	d-3.18
7 5/8	X021940A0	152	d-3.18
8 5/8	X022190A0	152	d-3.18
9 5/8	X022450A0	305	d-3.97
10 3/4	X022730A0	305	d-3.97
11 3/4	X022980A0	305	d-3.97
13 3/8	X023400A0	305	d-3.97
16	X024060A0	305	d-4.76
18 5/8	X024730A0	305	d-4.76
20	X025080A0	305	d-4.76

### Tubing Drift (Double Bail Type Drift )

Tubing Size (in)	Product Code	O.D. (mm)	Length (mm)
2 3/8	X020600A0	500	d-2.38
2 7/8	X020730A0	500	d-2.38
3 1/2	X020890A0	500	d-3.18
4	X021010A0	600	d-3.18

### Heavy Weight Drill Pipe Drift (Double Bail Type Drift )

Drill pipe specification(in)	Length (mm)	Minimum diameter	Length (mm)
All sizes	600	d-6.35	d-2.38

### Drill Pipe Drift (Double Bail Type Drift )

Casing Size(in)	Drill pipe specification(in)	Length (mm)	Minimum diameter(mm)
All sizes	≤ 3 1/2	500	d-3.18
	≥ 4	600	d-3.18

### Drill Collar Drift (Double Bail Type Drift )

Drill pipe specification (in)	Length (mm)	Minimum diameter (mm)	Length (mm)
All sizes	600	d-3.18	d-2.38

Lifting caps are tools for lifting of drilling tools, such as drill collars or stabilizers

## Specifications - Lifting Cap

Connection	Product Code	O.D. (mm)	Length (mm)	Connection	Product Code	O.D. (mm)	Length (mm)
7 5/8 REG Pin	J061501	220	290	7 5/8 REG Box	J061601	230	290
6 5/8 REG Pin	J062301	190	280	6 5/8 REG Box	J061301	200	280
4 1/2 REG Pin	J062201	140	260	4 1/2 REG Box	J060805	140	260
3 1/2 REG Pin	J060401	111	210	3 1/2 REG Box	J062103	111	250
2 3/8 REG Pin	J060102	80	190	2 3/8 REG Box	J062102	80	200
NC50 Pin	J060802	165	270	NC50 Box	J060804	165	260
NC46 Pin	J060801	150	270	NC46 Box	J060803	150	260
NC38 Pin	J060501	121	260	NC38 Box	J060602	121	260
NC31 Pin	J060402	105	220	NC31 Box	J060601	105	220
NC26 Pin	J060201	89	200	NC26 Box	J062101	89	200
2 7/8 EUE Pin	J060105	80	220	2 7/8 EUE Box	J060303	93	200



Pin Type Lifting Cap



Box Type Lifting Cap

## Quick-Detachable Casing Protector

Quick-detachable casing protector is a manual device to protect external threads of casing.

This protector is designed with simple configuration for easy operation. It consists of solid and durable synthetic rubber and high quality steel plate. Steel plate is fixed with bulge wheel lock assembly. The bulge wheel assembly can be locked or opened with the pulling handle.

Quick-detachable casing protector is applicable for casing with BTC, LTC, STC, and vAM threads.

## Specifications - Quick-Detachable Casing Protector

Model	Product Code	Applicable Diameter of Tubulars (in)	Model	Product Code	Applicable Diameter of Tubulars (in)
2 3/8	H106001	2 3/8 Tubing	7 5/8	H219401	7 5/8 Casing
2 7/8	H107301	2 7/8 Tubing	8 5/8	H221901	8 5/8 Casing
3 1/2	H108901	3 1/2 Tubing	9 5/8	H224501	9 5/8 Casing
4 1/2	H111401	4 1/2 Tubing	10 3/4	H227301	10 3/4 Casing
5	H112701	5 Tubing	13 3/8	H234001	13 3/8 Casing
5 1/2	H114001	5 1/2 Tubing	16	H240601	16 Casing
6 5/8	H116801	6 5/8 Tubing	18 5/8	H247301	18 5/8 Casing
7	H117801	7 Tubing	20	H250801	20 Casing



Quick-Detachable Casing Protector

Kelly valve is a manually operated ball type valve for the drill stem, divided into upper and lower sections. The upper Kelly valve is connected between lower end of swivel and upper end of Kelly. The lower Kelly valve is connected between upper end of drill pipe and lower end of Kelly or lower end of Kelly saver subs. The Kelly valve can be opened or closed off by simply turning a special operating wrench 90° according to indicated direction.

The sealing principle for Kelly valve is to ensure a close seat between the ball and the ball seat. The lower seat is supported by a spring. The force provided by the spring keep the ball securely in place with lower seat. During normal drilling operation, the hole is kept unblocked by turning the stem to “on” position; In case of kick or blowout, turn the operating stem to “off” position to close off the internal bore of drill string, the kick or blowout accident is avoided due to a high pressure sealing situation between ball and the ball seat.

### When ordering please specify:

- Upper or Lower type;
- Tool OD;
- Working pressure: 5,000 / 10,000 / 15,000 psi;
- Tool connection.



Kelly valve  
(F02)

### Specifications - upper Kelly valve

Model	Product Code	O.D. (mm)	Thread connection (LH)	I. D. (mm)	Max. Sealing Pressure (MPa)
CS 146K	F021461	146	4 1/2 REG	57.2	68.6
CS 197K	F021971	197	6 5/8 REG	76.2	68.6
CS 200K	F022001	200	6 5/8 REG	76.2	68.6

### Specifications - Lower Kelly valve

Model	Product Code	O.D. (mm)	Thread connection (LH)	I. D. (mm)	Max. Sealing Pressure (MPa)
XS105K	F021051	105	NC31	40	68.6
XS121K	F021211	121	NC38	44.5	68.6
XS127K	F021271	127	NC38	44.5	68.6
XS140K	F021402	139.7	NC40	57.2	68.6
XS159K	F021591	159	NC46	61	68.6
XS165K	F021653	165	NC46	61	68.6
XS168K	F021681	168	NC50	71.4	68.6
XS178K	F021782 , F021782	178	NC50 , 5 1/2 FH	71.4	68.6

Full Opening Safety valve (FOSv) is a ball type safety valve used to stop flow through the drill string when the drill string is being withdrawn from the well.

TIANHE FOSv is a dual body full-opening safety valve, that does not interfere with the running of tools such as core barrels or survey instruments. It is designed to be stabbed into the top joint of drill pipe or tubing string at the rig floor and closed quickly in case a well kicks.

The ball-type design permits the valve to be compact, easy to handle, and have great strength. Standard test pressure is 10,000 psi, but higher pressure ratings are available.

FOSv and operating wrench be should be maintained on the rig floor at all times.

### When ordering please specify:

Connection.  
O.D. and I.D.



Full Opening  
Safety valve  
(F07)

### Specifications - Full Opening Safety valve

Model	XS105-T44	XS110-T51	XS124-T62	XS127-T62	XS133-T57	XS133-T57	XS134-T62
Product Code	F071052	F071101	F071241	F071271	F071331	F071333	F071348
O.D.	Φ105	Φ110	Φ124	Φ127	Φ133	Φ133	Φ134
I.D.	Φ44	Φ51	Φ62	Φ62	Φ57	Φ57	Φ62
Connection	NC26	NC31	2 7/8 EUE	2 7/8 EUE	XT39	4 1/2 VAM	NC38
Length	732	726	578	578	773	1173	800

### Specifications - Full Opening Safety valve

Model	XS134-T62	XS146-T50.8	XS152-T76	XS152-T76	XS178-T76	XS178-T76.2	XS190-T82.6
Product Code	F071344	F071461	F071522	F071521	F071782	F071787	F071902
O.D.	Φ134	Φ146	Φ152	Φ152	Φ178	Φ178	Φ190
I.D.	Φ60	Φ50.8	Φ76	Φ76	Φ76	Φ76.2	Φ82.6
Connection	4 1/2 NU	NC31	3 1/2 NU	3 1/2 EUE	3 1/2 EUE	NC46	NC50
Length	560	832	640	617	675	885	895



Drop-In Check valves prevent return flow during a kick and are suitable for most drilling situations in which return flow through the drill string is a risk and normal operation requires the benefits of a full-bore sub. By preventing upward flow through the drill pipe and allowing fluid to be pumped downward to circulate the well, the valves provide the driller with the means to control the drill pipe pressures when required, significantly improving and simplifying well control.

When a blowout is about to happen, the thread connections of the kelly is screwed out immediately and a check valve is placed into the drill pipe and then pumped downward to the required place. Thus the blowout can be prevented.

### When ordering please specify:

- Smallest bore in drill string through which the check valve must pass.
- Landing sub connection size and type.
- Outside diameter of mating tool joints.



Check valve

Landing Sub

FT Type Drop-in  
Check valve  
(F03)

### Specifications - Drop-In Check valve

Specification	Product Code	Check valve Assembly O.D.(mm)	Landing Sub O.D.(mm)	Stop Ring I.D.(mm)	Working Pressure (MPa)	API Connection
FT89	F030892	34	89	31	35 (70)	NC26
FT105	F031051	34	105	31		NC31
FT121	F031213	50	121	46		NC38
FT159	F031591	54	159	50		NC46
FT168	F031681	68	168	64.5		NC50
FT178	F031782	68	178	64.5		5 1/2 FH
FT203	F032032	68	203	64.5		6 5/8 REG

Inside BlowOut Preventor (IBOP) is a special tool, which can be stripped through the BOP preempt to be connected with the added drilling tools as soon as possible. When the blowout occurs during lifting operations, the IBOP have many advantages in situation such as, high pressure rating, reliable seal, easy application and operation.

When the drill tool is lifted out of the hole, blowout could happen due to suction. In event of a blowout, the open position of the IBOP valve allows back flow, easing the installation process. Upon successful installation, the valve can be promptly closed with a relief rod to prevent further back flow. Fluid can then be pumped in from the surface to discharge the IBOP and drill string. The purpose of the blowout prevention can be achieved by the following generic steps: discharging the relief sub; regulation of fluid; commence pump circulation.

When ordering please specify the connection of drill string.



Inside BOP  
(F01)

### Specifications - Inside BOP

Inside Blowout					
Thread connection	Product Code	O.D. (in)	I.D. (in)	Length (in)	Working Pressure (MPa)
NC26	F0108900	3 1/2	1 1/4	27~28	70 (35)
NC31	F0110500	4 1/8	1 5/8	28~30	70 (35)
NC38	F0112100	4 3/4	2	30~31	70 (35)
NC46	F0115900	6 1/4	2 7/16	33~34	70 (35)
NC50	F0116800	6 5/8	2 13/16	33~34	70 (35)
5 1/2 FH	F0117800	7	3	35~38	70 (35)
6 5/8 REG	F0120300	8	3	38	70 (35)
7 5/8 REG	F0124100	9 1/2	3	38	70 (35)

TIANHE Arrow Type Back Pressure valve is an important tool preventing of blowout.

The design of the Arrow Type Back Pressure valve allows for an on-site determination of back pressure to be set at surface.

### Features and Benefits

- Metal to metal sealing;
- Simple design allows easy maintenance.

### When ordering please specify:

- Size;
- Thread connection.

note: Arrow Type Back Pressure valves are not ideally suited for cementing or abrasive fluids.

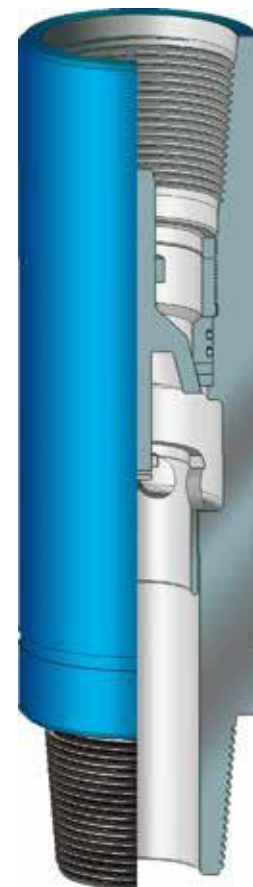

FJ Type-Arrow  
Back Pressure  
valve  
(F04)

### Specifications - Arrow Type Back Pressure Valve

Model	Product Code	O.D.(mm)	Connection	I.D.(mm)	Working Pressure(MPa)
FJ229	F042291	229	7 5/8 REG	82	70 (35)
FJ203	F042031	203	6 5/8 REG	82	70 (35)
FJ178	F041784	178	5 1/2 FH	82	70 (35)
FJ168	F041681	168	NC50	82	70 (35)
FJ165	F041652	165	NC50	82	70 (35)
FJ159	F041591	159	NC46	70	70 (35)
FJ121	F041211	121	NC38	56	70 (35)
FJ105	F041051	105	NC31	44	70 (35)
FJ89	F040891	89	NC26	33	70 (35)

Float valve Sub is an important tool in petroleum exploration and drilling engineering. The float valve sub is connected at upper part of drill bit. The float valve sub is near the bit connecting thread. The float valve sub can also be used at different necessary position of drill string when required. The main application is, when connected with single piece pipe, it prevents mud from coming in and up blocking the hole. When blowout takes place, blowout in drill string will be avoided because nozzle is closed automatically by valve cap of the float valve assembly .

### When ordering please specify:

- Float valve type (Model F or Model G);
- Float valve size;
- Connection and O.D of sub.



Model F  
Float valve



Model G  
Float valve



Model F Float Sub



Model G Float Sub

Float valve Sub  
(J09)

### Specifications - Float valve Sub

Model	Product Code ( with arrow type float valve)	Product Code ( with plate type float valve)	Sub O.D. (mm)	Connection	valve O.D. (mm)	I.D. (mm)
FFJT241	J0917110	J1017110	Φ241.3	7 5/8 REG B×B	Φ121 (5F6R)	Φ76.2
FFJT228	J0916140	J1016140	Φ228.6	7 5/8 REG B×B	Φ121 (5F6R)	Φ76.2
FFJT209	J0915040	J1015040	Φ209.6	6 5/8 REG B×B	Φ121 (5F6R)	Φ71.4
FFJT203	J0914110	J1014110	Φ203.2	6 5/8 REG B×B	Φ121 (5F6R)	Φ71.4
FFJT178	J0912090	J1012090	Φ177.8	4 1/2 REG B×NC50 B	Φ88 (4R)	Φ71.4
FFJT165	J0909240	J1009240	Φ165.1	4 1/2 REG B×NC50 B	Φ88 (4R)	Φ71.4
FFJT159	J0908070	J1008070	Φ158.8	4 1/2 REG B×NC46 B	Φ88 (4R)	Φ71.4
FFJT127	J0907130	J1007130	Φ127	3 1/2 REG B×NC38 B	Φ61 (2F3R)	Φ50.8
FFJT105	J0904060	J1004060	Φ104.8	2 7/8 REG B×NC31 B	Φ48 (1F2R)	Φ38.1

During drilling operation, when a well kick takes place and bit bore is blocked, the by-pass valve can be opened to allow fluid circulation and well killing. Before drilling in a gas formation, the By-Pass valve shall be located near or on the bit.

When well kick take place and pump pressure is too high or blocked, the following steps can be taken to open the By-Pass valve :

- Discharge Kelly and drop in a steel ball (or a nylon ball) which is carried by tool;
- Connect with Kelly;
- Put ball into retainer by pump circulation;
- When fluid is closed, the shear pin can be sheared off by adding 0.5~1.5MPa higher pump pressure than original pump pressure;
- After pin is sheared, the seal sleeve move down to open the discharge hole and pump pressure come to drop down , then normal circulation and well killing operation can be started.

#### When ordering please specify:

- O.D. of body;
- Connection;
- Pump pressure required to shear off pin (per customer requirement)

#### Specifications - By-Pass valve

型号	产品代码	外径 (mm)	密封套 (mm)	上螺纹 (母扣)	下螺纹	剪短剪销 的泵压	钢球外径 (mm)
PTF105	F061053	105	32	NC31	NC31 (PIn)	3-10 MPa	35
PTF121A	F061213	121	38	NC38	NC38 (PIn)	3-10 MPa	45
PTF127	F061273	127	38	NC38	NC38 (PIn)	3-10 MPa	45
PTF127C	F061272	127	38	NC38	3 1/2 REG (BOx)	3-10 MPa	45
PTF159	F061591	159	49	NC46	NC46 (PIn)	3-10 MPa	54
PTF159B	F061594	159	49	NC46	4 1/2 REG (BOx)	3-10 MPa	54
PTF168	F061681	168	50.8	NC50	NC50 (PIn)	3-10 MPa	57
PTF203	F062031	203	62	6 5/8 REG	6 5/8 REG (PIn)	3-10 MPa	65

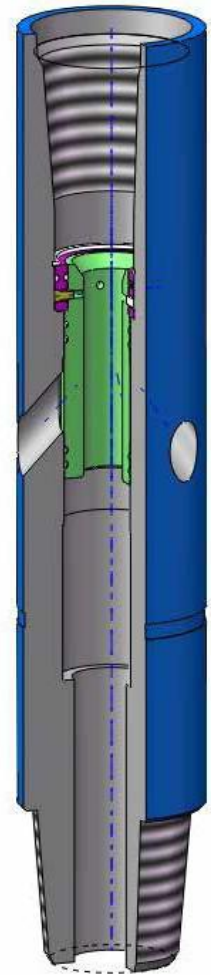

By-Pass valve  
(F06)



During drilling operation, when a well kick takes place and bit bore is blocked, the by-pass valve can be opened to allow fluid circulation and well killing. Before drilling in a gas formation, the By-Pass valve shall be located near or on the bit.

When well kick take place and pump pressure is too high or blocked, the following steps can be taken to open the By-Pass valve:

- Discharge Kelly and drop in a steel ball (or a nylon ball) which is carried by tool;
- Connect with Kelly;
- Put ball into retainer by pump circulation;
- When fluid is closed, the shear pin can be sheared off by adding 0.5~1.5MPa higher pump pressure than original pump pressure;
- After pin is sheared, the seal sleeve move down to open the discharge hole and pump pressure come to drop down, then normal circulation and well killing operation can be started.

#### When ordering please specify:

- O.D. of body;
- Connection;
- Pump pressure required to shear off pin (per customer requirement).

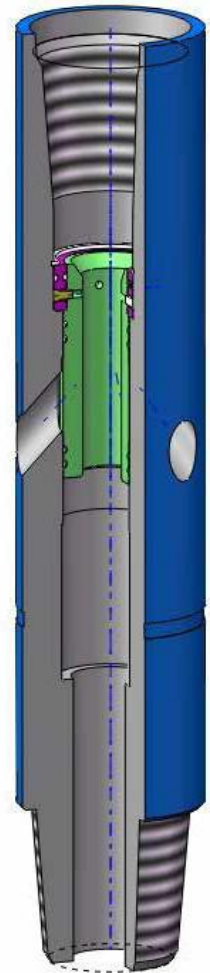

By-Pass valve  
(F06)

#### Specifications - By-Pass valve

Model	Product Code	O.D. (mm)	Seal Sleeve (mm)	Top Connection (Box)	Bottom Connection	Pump Pressure of shear-off shear pin	O.D. of Steel Ball (mm)
PTF105	F061053	105	32	NC31	NC31 (Pin)	3-10 Mpa	35
PTF121A	F061213	121	38	NC38	NC38 (Pin)	3-10 Mpa	45
PTF127	F061273	127	38	NC38	NC38 (Pin)	3-10 Mpa	45
PTF127C	F061272	127	38	NC38	3 1/2 REG (Box)	3-10 Mpa	45
PTF159	F061591	159	49	NC46	NC46 (Pin)	3-10 MPa	54
PTF159B	F061594	159	49	NC46	4 1/2 REG (Box)	3-10 MPa	54
PTF168	F061681	168	50.8	NC50	NC50 (Pin)	3-10 MPa	57
PTF203	F062031	203	62	6 5/8 REG	6 5/8 REG (Pin)	3-10 MPa	65

Cup tester is designed to be attached to the drill string and lowered into the casing beneath the wellhead to test the pressure of the blowout preventer stack and the wellhead. When the cup tester is lowered into the casing beneath the wellhead, pressure is applied to either a test pump or hoisting type cup after filling the hookup with water. This method is fast and accurate.

The Cup Tester assemblies are rated to the API standard mill test pressure for casing sizes up to 10,000 psi. We offer special reinforcing on all cup sizes and casing weight ranges to hold up to 15,000 psi.

When ordering please specify:

- Casing size & weight;
- Connection.



Cup Tester  
(J14)

## Specifications - Cup Tester

Model	Product Code	Connection	Applicable casing dimensions				Rubber cup O.D. (mm)	Bearing area of plug O. D. (mm)	Max. bearing pressure (Mpa)	Length (mm)
			O.D. (in)	I. D.						
				(mm)	Wall thickness	ppf				
TSQ127	S12700	NC26	5	114.1-112.0	6.43-7.52	13.0-15.0	A 117	71	70	640
				108.6-104.8	9.19-11.1	18.0-21.4	B 112	62		
TSQ140	S14000	NC31	5 1/2	125.7-124.3	6.98-7.72	15.5-17.0	A 129	82	70	700
				121.4-118.6	9.17-10.54	20.0-23.0	B 125	74		
TSQ178	S17800	NC38	7	164.0-159.4	6.91-9.19	20.0-26.0	A 167	148	70	700
				157.1-152.5	10.36-12.65	29.0-35.0	B 160	130		
TSQ245	S24400	NC50	9 5/8	226.6-224.4	8.94-10.03	36.0-40.0	A 230	302	35	840
				222.4-216.8	11.05-13.84	43.5-53.5	B 226	287		
TSQ273	S27300	NC50	10 3/4	255.3-250.1	8.89-11.43	40.5-51.0	A 259	413	35	840
				247.9-242.8	12.57-15.11	55.5-65.7	B 251	381		
TSQ339	S33900	NC50	13 3/8	320.4-317.9	9.65-10.92	54.0-61.0	A 325	628	35	840
				315.3-313.6	12.19-13.06	68.0-72.0	B 320	602		
TSQ508	S50800	NC50	20	485.7-482.6	11.13-12.70	94-106.5	A 490	1570	35	1010
				475.7	16.13	133	B 480	1494		

QY type high temperature hydraulic drilling jar is a new generation of double-acting hydraulic jar that is fully upgraded by our company on the basis of the original QY full-hydraulic drilling jar. It has the characteristics of simple operation, adjustable shock tonnage, high temperature resistance, etc. This type of drilling jar adopts a new hydraulic delay release system, which has excellent reliability and wide adaptability.

## Application

It is suitable for all conventional wells, inclined wells and large displacement wells at all temperatures not higher than 204°C.

## Features

The superior machine structure is to further improve the machine maintainability.

The unique sealing structure is designed to improve the temperature resistance and improve the sealing reliability.

The core mechanism adopts the seal oil bath design to reduce the wear and tear of the moving parts and improve the life of the whole machine.

The overflow area of the release channel is increased to reduce the running resistance and greatly improve the shock effect.

The operating force of hydraulic releasing mechanism can be controlled on the ground by driller, and can be flexibly adjusted according to the downhole situation.

The optional mechanical locking module is added to meet the needs of some special users.

The optional mechanical locking module is added to meet the needs of some special users.

Increase the fast recovery function of the upward and downward strokes. The mandrel moves back to the middle position, and then the jar will do jarring again in either of the two directions.

## Technical parameters table

Model	QY79	QY89	QY95	QY108	QY121	QY165	QY178	QY203	QY241	
OD in (mm)	80	90	96	109	122	167	181	206	244	
ID in (mm)	25	32	32	38	50	57 (70)	70	76	76	
operating Temperature(°C)	204									
Tensile strength(KN)	600	750	1000	1350	1950	3750	4650	6030	8500	
torsional strength (KN·m)	6	7	8	16	25	70	80	135	165	
Allowable release force KN	Upward jarring	150	180	200	250	350	700	800	1000	1250
	Downward jarring	60	90	100	120	180	350	400	500	650
Upward/Downward jarring stroke in (mm)	10 7/16				12 1/2					
	265				317.5					
Total stroke in (mm)	20 7/8				25					
	530				635					
connection 连	2 3/8REG NC23	2 7/8REG NC26	2 7/8REG NC26	NC31	NC35 NC38	NC50	NC50	6 5/8REG	7 5/8REG	

Note: The tensile strength and torsion strength are based on the nominal size of the tool and the standard yield and tensile value of the material, which are calculated according to the API RP7G. These data do not have a direct or indirect legal guarantee.

QY type hydraulic drilling jar is a new generation of double-acting hydraulic jar that is fully upgraded by our company on the basis of the original QYSZ II type full-hydraulic drilling jar. It has the characteristics of simple operation, adjustable shock tonnage, high temperature resistance, etc. This type of drilling jar adopts a new hydraulic delay release system, which has excellent reliability and wide adaptability.

## Application

It is suitable for all conventional wells, inclined wells and large displacement wells at all temperatures not higher than 160°C.

## Features

The superior machine structure is to further improve the machine maintainability.  
The better sealing materials are selected to improve the reliability of sealing

The core mechanism adopts the seal oil bath design to reduce the wear and tear of the moving parts and improve the life of the whole machine.

The overflow area of the release channel is increased to reduce the running resistance and greatly improve the shock effect.

The operating force of hydraulic releasing mechanism can be controlled on the ground by driller, and can be flexibly adjusted according to the downhole situation.

The optional mechanical locking module is added to meet the needs of some special users.  
Increase the fast recovery function of the upward and downward strokes. The mandrel moves back to the middle position, and then the jar will do jarring again in either of the two directions.



## Technical parameters table

Model		QY79	QY89	QY95	QY108	QY121	QY165	QY178	QY203	QY241
OD in (mm)		80	90	96	109	122	167	181	206	244
ID in (mm)		25	32	32	38	50	57 (70)	70	76	76
operating Temperature (°C)		160								
Tensile strength (KN)		600	750	1000	1350	1950	3750	4650	6030	8500
torsional strength (KN·m)		6	7	8	16	25	70	80	135	165
Allowable release force KN	Upward jarring	150	180	200	250	350	700	800	1000	1250
	Downward jarring	60	90	100	120	180	350	400	500	650
Upward/Downward jarring stroke in (mm)		10 7/16				12 1/2				
		265				317.5				
Total stroke in (mm)		20 7/8				25				
		530				635				
connection		2 3/8REG NC23	2 7/8REG NC26	2 7/8REG NC26	NC31	NC35 NC38	NC50	NC50	6 5/8REG	7 5/8REG

Note: The tensile strength and torsion strength are based on the nominal size of the tool and the standard yield and tensile value of the material, which are calculated according to the API RP7G. These data do not have a direct or indirect legal guarantee.

QYSZIII New Double Acting Hydraulic Drilling Jar is a new hydraulic drilling jar with locking mechanism developed on the basis of the structure of QYSZII double-acting hydraulic drilling jar. Besides the advantages of QYSZII type, it also has the following advantages.

1. The mechanical locking mechanism prevents unnecessary wear of the internal parts during the working process, and improves the working life.
2. The mechanical locking mechanism is functional safety and reliability, which is made by special process. The friction resistance is small, and the locking force is linear stability.
3. The locking mechanism can avoid the failure jarring caused by misoperation when connect simple root to the drill string or contact the hole bottom.

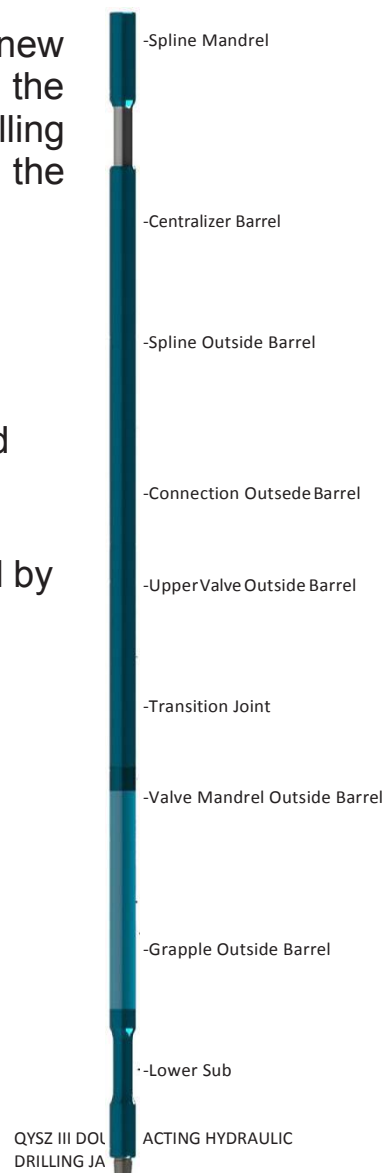

Specifications - Double Acting Hydraulic Drilling Jar

Model	QYSZIII 108	QYSZIII 121	QYSZIII 165	QYSZIII 203	QYSZIII 241	
OD in (mm)	109	122	167	206	244	
ID in (mm)	38	50.8	57 (70)	76	76	
Working temperature °C	150					
Tensile strength (KN)	1350	1950	3750	6230	8500	
Torsional strength (KN·m)	16	25	70	135	165	
Unlocking Force 解锁力 (KN)	Up jarring	160±25	180±25	420±25	425±25	425±25
	Down jarring	70±25	80±25	180±25	205±25	205±25
Maximum release force (KN)	Up jarring	250	350	700	1000	1250
	Down jarring	120	180	350	500	650
total stroke in (mm)	20 7/8	25				
	530	630				



The drilling jar consists of drilling up jar and drilling down jar in one body, which has stable working performance and strong jarring force both up and down. When in down hole, it can release the stuck; it is a desire tool for directional well and deep well.

## Working Principle

### Up Jarring

Lowering drill string to make drilling jar closed completely (in locking position), elevating drill string by the order of small tonnage to larger tonnage, which make spring and hydraulic cylinder delay, when mandrel move to a position and become release resistance, the spring force stored in drill string will transfer to up forward energy and up jarring. Repeating the above several times can force tool to produce continues up jarring.

### Down Jarring

Move up and down the drill string to make drilling jar closed completely (in locking position), lowering drill string to make spring compressed and stored energy. When pressure of jar is larger than the desired lower unlocking force, grapple will slide out from mandrel to release the locking and make down jarring. Repeating the above several times can force tool to produce continues down jarring.

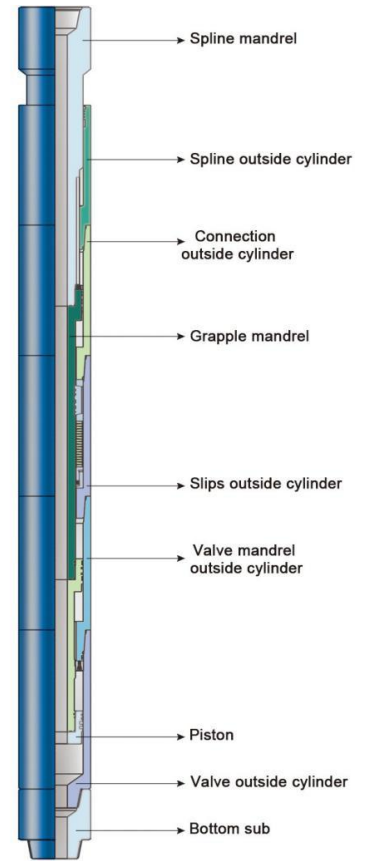

JYSZ Double Acting Hydraulic-Mechanical Drilling Jar

## Specifications - JYSZ Double Acting Hydraulic-Mechanical Drilling Jar JYSZ

Model	JYSZ121	JYSZ159	JYSZ165	JYSZ178	JYSZ203	JYSZ241
OD in (mm)	121	159	165	178	203	241
ID in (mm)	51	57.2	57.2	64	71.4	76.2
API connection	NC38	NC46	NC50	NC50	6 5/8REG	7 5/8REG
Up jarring free stroke in (mm)	6	6	6	6	6	6
	152	152	152	152	152	152
Down jarring free stroke in (mm)	6	6	6	6	6	6
	152	152	152	152	152	152
MAX. jarring force (KN)	350	700	700	800	1000	1250
Rated Release Force for Up jarring (KN)	200~240	400~450	400~450	400~450	450~500	450~500
Rated Release Force for DOWn jarring (KN)	80~100	180~200	180~200	180~200	190~210	200~220
Max. Tensile Load (KN)	1600	3400	3400	3700	4400	5400
Working Pull Force (KN)	1100	2000	2000	2400	2800	3500
Max. Torque (KN·m)	20	51	51	60	100	129
Working Torque (KN·m)	15	25	25	30	35	40
Pump Area (cm <sup>2</sup> )	75.4	126.6	126.6	143.1	198.5	283.4

QJZ type mechanical drilling jar is a kind of fully-mechanical jarring tools. It can release the drilling tools sticking accidents by providing a up and down jarring force. Basically, it is part of the drill stem, whenever needed, the jarring force can increase the working efficiency.

### Up Jarring Working Principle

It show us the jarring state unlocked after be adjusted when it comes to the jarring position the moving axis should snap in the inside threads of the slips. The outer thread of the slips and inside sleeve are under the friction state with. When lifting the drill stem, the upper sub, upper control sleeve, middle sleeve lower control sleeve, lower regularing sleeve, spring type inside sleeve, spring middle sleeve, and spring outer sleeve will move upward while friction sleeve keep still. The slips can be opened when its outer thread top touch the friction sleeve's teeth, at the moment the teeth of the axis will move out from the slips' inside teeth, Then stored power will release and give a up and down double-way force, the tool will return to the state the ready to jarring position. Repeat the following operation, we can release the sticking drilling tools.

### Lower Jarring Working Principle

There are a set of spring sleeve on the top of the slips. When the stem give a pressure on the jar, it can pass through the upper sub, upper control sleeve, upper regularing sleeve to work on the, spring type inside sleeve, spring middle sleeve, and spring outer sleeve. Slips will move upwards while the friction sleeve keep still, until reach the predetermination position, the teeth top of the slips will touch the teeth of the friction sleeve, slips will open to let the moving axis release from the slips teeth, the down-way jarring force against the upper jarring force.

### Specifications - QJZ Mechanical Drilling Jar

Model	QJZ121	QJZ159	QJZ165	QJZ178	QJZ203	QJZ229
OD in (mm)	121	159	165	178	203	229
ID in (mm)	51	57	57	57	71.4	76.2
Up Stroke in (mm)	7 7/8	5 5/8	5 5/8	5 7/8	5 13/16	8
	200	142	142	149	145	203
Down Stroke in (mm)	7 7/8	6 3/4	6 3/4	5 5/8	7	8
	200	172	172	168	178	203
Max. Up Jarring Farce (KN)	400	600	620	700	800	1000
Max. Down Jarring Farce (KN)	250	350	350	420	450	500
Max Tensile Load (KN)	1400	2200	2200	2200	2500	3000
Max. Working Torque (KN·m)	10	15	15	15	20	25
Connection	NC38	NC46	NC50	NC50	6 5/8REG	7 5/8REG
Pump Area (cm <sup>2</sup> )	70.8	115.7	115.7	132.7	174.3	240.4

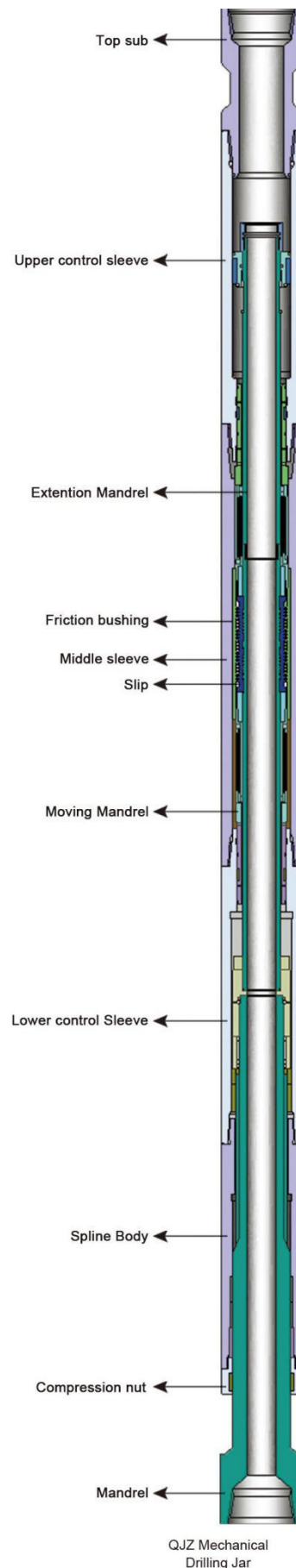

QJZ Mechanical Drilling Jar

The drilling jar connecting with drill tool and working with drill strings is a downhole stuck freeing tool in drilling operation. When drill tool is happened to be stuck in downhole, the stuck drill tool can be released by in time starting the drilling jar to provide continuous up jarring or down jarring. It is a desire tool for directional well, complicated well and deep well.

The drilling jar is consisting of ZSJ type drilling up jar and ZXJ type drilling down jar, both can be used mutually or operated separately. The up jarring section takes use of hydraulic mechanism; the jarring force can be adjusted according to up elevating load but can not exceed the max. load for tool load rated. The down jarring section takes use of mechanical friction mechanism; the jarring force is well pre-adjusted by adjusting device before put into down-hole. No re-adjustment can be allowed after jar is put into down-hole.

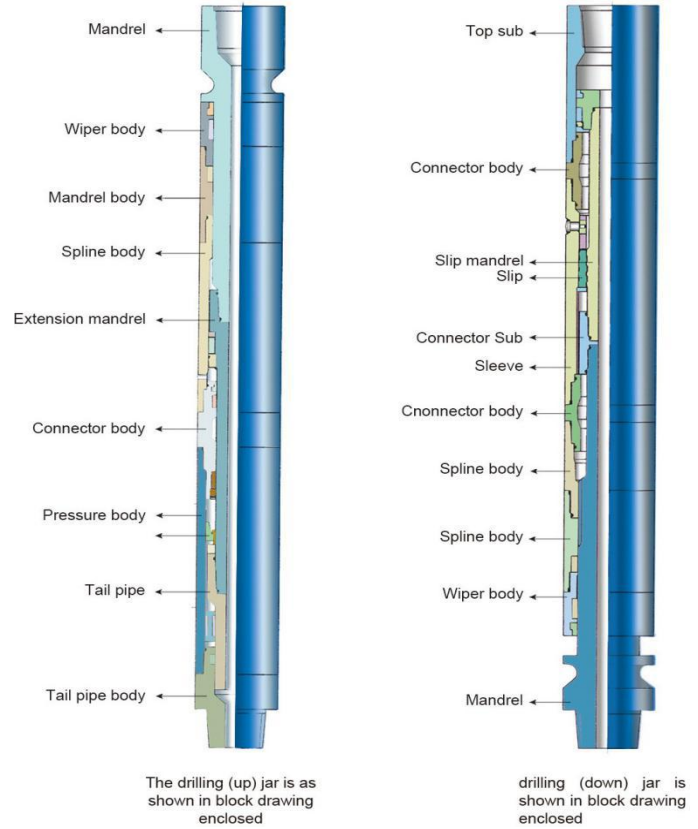

## Specifications - ZSJ/ZXJ Hydraulic & Mechanical two-piece Drilling Jar

Model	ZSJ94B	ZSJ90B	ZSJ80B	ZSJ76B	ZSJ70B	ZSJ66B	ZSJ64B	ZSJ62B	ZSJ56B	ZSJ46B
	ZXJ94B	ZXJ90B	ZXJ80B	ZXJ76B	ZXJ70B	ZXJ66B	ZXJ64B	ZXJ62B	ZXJ56B	ZXJ46B
OD in (mm)	241	229	203	197	178	172	165	160	146	121
ID in (mm)	76	76	71.4	71.4	70	63.5	57	57	57	47
Up Stroke in (mm)	13 1/2	13 1/2	14 1/2	14 1/2	13 1/2	<b>13 1/2</b>	<b>13 1/2</b>	<b>13 1/2</b>	13	<b>13 1/2</b>
	343	343	368	368	344	344	344	344	332	305
Down Stroke in (mm)	10	10	7 1/8	7 1/8	7	7	7	7	7 1/8	7
	254	254	181	181	178	178	178	178	180	178
API connection	7 5/8REG	7 5/8REG	6 5/8REG	6 5/8REG	NC50	NC50	NC50	NC46	4 1/2FH	NC38
Max. Tensile Load (KN)	2800	2800	2500	2500	2300	2200	2200	2200	2000	1400
Allowable Working Torque (KN·m)	22	22	20	18	15	15	15	15	15	13
Rated Release Force for Up jar (KN)	500~700	500~700	400~600	400~600	350~550	350~550	300~450	300~450	200~350	150~250
Max. Up Jarring release Force (KN)	1000	1000	750	750	700	700	550	550	450	270
Max. Down Jarring release Force (KN)	650	650	600	600	550	550	500	500	400	250

The SY type two ways shock absorbers are used to simultaneously slow down or eliminate the vertical or **horizontal** shock from drill string. It can reduce the damage due to shocking to drill bit, drilling tool and surface drilling tool so as to enhance drilling speed and reduce drilling cost.

## Working Principle

The torsion of bottom hole will be changed with changes in bit structure, formation and bit weight . When the drilling speed reaches up to a certain value, torque and resonance will be happened to drill string. During rotation drilling, the lower part of drilling tool simultaneously bear axially pressure and torque. When bit weight exceed the limit value, the drilling tool will produce a transverse bending (it means lose steadiness) and torque can also make the drilling tool to lose steadiness to be turned into a twist shape. Two positions are very typical: 1.The lower bit is suddenly frozen and then torque bumping will be produced unless the cut down rotary energy. 2. Reversing operation in force.

The vertically damping unit is made of mandrel, piston assembly, annular space damping unit and liquid spring of working chamber. Working mechanism: To absorb or release the vibration energy of bit and drill string by means of compressible liquid producing spring deformation in working chamber under the function of pressure. The mandrel moves axially relative to outer barrel when liquid spring is in compression or explanation. Meanwhile, the non-compressible liquid in damping chamber flows through damping space and produces a large number of friction heat so that some vibration and bumping energy are used up. The vertical bumping unit thus can absorb or reduce the drilling **tools' energy** in vertical vibration and bumping.

The piston change-over unit is composed of spline outer barrel which is connected with piston by rectangular spline pair and the piston inner hole which is connected with mandrel by ladder-shaped spiral pair. Such a group unit can turn the torque vibration and impact load into vertical component of force in working chamber in a twinkling of an eye so that a constant torque is maintained on.

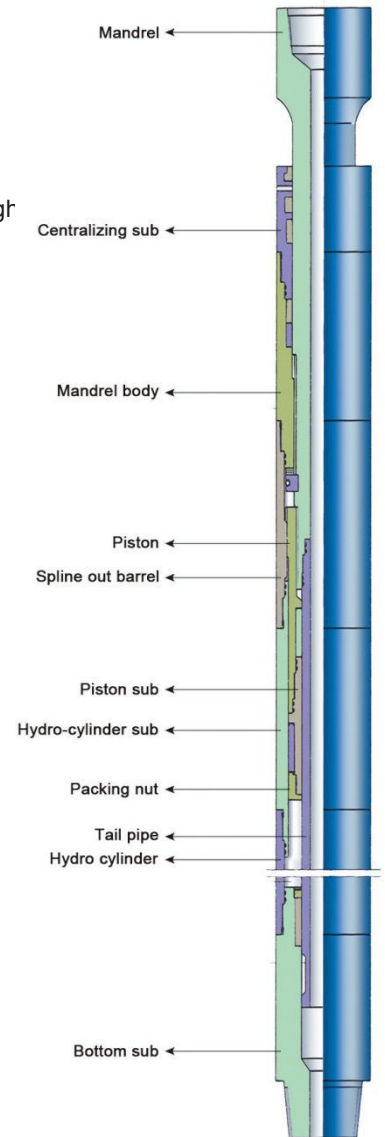

SJ Double-Way Shock Absorber

## Specifications - SJ Double-Way Shock Absorber

Model	SJ46B	SJ62C	SJ64C	SJ70C	SJ80C	SJ90C	SJ94C
OD in (mm)	121	160	165	178	203	229	241
ID in (mm)	38	47	47	57	64	71	71
Max. Stroke in (mm)	4 5/16	4 3/4	4 3/4	4 5/16	4 3/4	4 3/4	4 3/4
	110	120	120	100	120	120	120
Ambient temperature (°C)	-40 ~150						
Max. Torque (KN-m)	10	15	15	15	20	20	20
Max.Bit weight (KN)	200	340	340	400	480	540	540
Tensile Load (KN)	1000	1500	1500	1500	1960	1960	1960
Connection	NC38	NC46	NC50	NC50	6 5/8REG	7 5/8REG	7 5/8REG

The YJ type one-way shock absorber (bumper) is a kind of drilling tool. It can effect shock absorbing and shock reduction by means of elastic deforming and **anti-coagulation** produced from hydraulic oil under the outside force. Its advantages such as simple structure, reliable working performance and easy to maintain can well absorb shocking and vibrating load from drill strings during drilling operation. Therefore, using of shock absorber can raise in structure the service life of drill bit and drill pipe, speed up drilling, get rid of drilling jumping, well protect surface equipments and drilling tools.

## Working Principle

The hydraulic shock absorber is connected between drill bit and drill collar, the torque is transferred from top drill string to mandrel. The spline transfers torque to spline outer barrel, oil cylinder and lower sub, then drive drill bit to rotate.

The bit weight is from the which of top drill tool so that drill bit insert drill into formation to break rock into pieces. The drilling mud is fed through bore of drill pipe and drill collar into mandrel of shock absorber, tailpipe, lower sub bore and ejected into bottom well. Because of the uneven bottom well conditions and special structure of cone bit, the drill bit and drill string during drilling operation would produce severe vibration. The hydraulic shock absorber, by means of compressible deformation of compressed liquid under the function of pressure, absorb the energy from drill bit and drill string vibration. Thus, the shock absorber can reduce the vibration and impact load of drill tools.

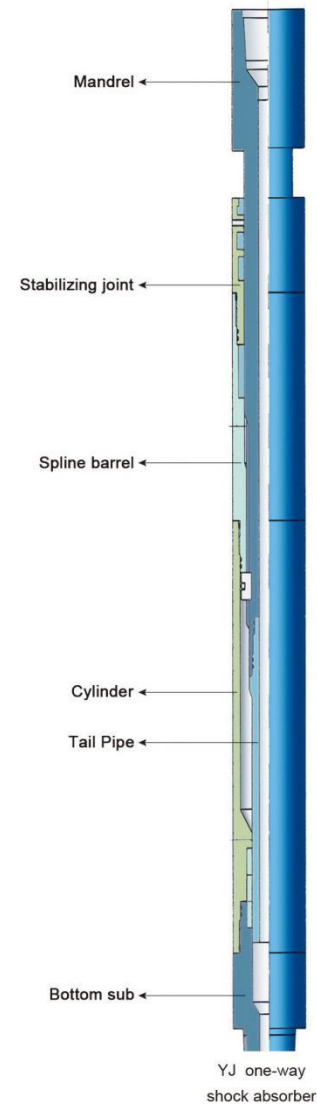

### Specifications - YJ one-way shock absorber

Model	YJ46C	YJ62C	YJ70C	YJ80C	YJ94C
OD in (mm)	121	160	178	203	241
ID in (mm)	38	47	57	64	70
Max. Stroke in (mm)	4 5/16	4 3/4	4 3/4	5 7/8	5 7/8
	100	120	120	150	150
Max. Bit weight (KN)	250	343	392	450	540
Tensile Strength (KN)	1000	1500	1500	2000	2000
Ambient temperature (°C)	150				
Connection	NC38	NC46	NC50	6 5/8REG	7 5/8REG

CSJ type super fishing jar is a fishing tool which the jarring force is larger than other jar with same specifications. It features a closed structure, reliable performance, easy to adjust and easy to operate. It is a new type of top jarring tool used in oilfield, geological exploration and drilling operation.

## Working Principle

CSJ type super fishing jar effects the top jarring action is by means of hydraulic mechanism which allows taper piston to move in cylinder and stores energy by raising drill tool. When the drill tool attached on the top of super fishing jar is raised, enough time is provided for drill tool to store energy due to the damping action between taper piston and sealing body in pressure body of super fishing jar. When taper piston moves to release bore, the drill tool shall suddenly attract and produce an upward dynamic load along with the instant unloading of high hydraulic oil. The reliable impact working face is designed in the product structure to ensure that large jarring force is provided to stuck fish (drill tool). A desire return mechanism is designed in order to make a reciprocating jarring action. In order to make a rotation for drill tool in down hole and a circulation for fluid, CSJ type of super fishing jar pass torque by means of spline and meanwhile enlarge the watercourse as far as possible to meet the tests with exception of fluid circulation and other applications.

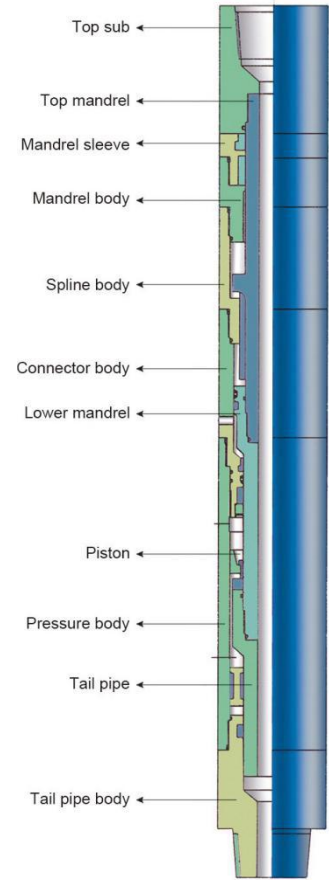

CSJ Super Fishing Jar

## Specifications - CSJ Super Fishing Jar

Model 型号	CSJ31B	CSJ34B	CSJ36B	CSJ42C	CSJ46B	CSJ62B	CSJ64B	CSJ70B	CSJ76B	CSJ80B	CSJ90B
O.D. in (mm)	80	89	95	108	121	160	165	178	197	203	229
I.D. in (mm)	25.4	25.4	28	38	45	57	57	60	71	71	76
Stroke in (mm)	298	298	298	305	305	320	320	320	330	330	330
Tensile Load (KN)	300	400	500	700	980	1270	1370	1570	1870	2100	2200
Max. Tension Downhole (KN)	150	180	200	250	400	700	750	800	800	800	1000
Max. Work Torque (KN·m)	3	3.5	4	6	8	15	15	17	20	22	25
sealing pressure (MPa)	30										
Max. working temperature (°C)	150										
Connecting	2 3/8REG	NC26	NC26	NC31	NC38	NC50	NC50	NC50	6 5/8REG	6 5/8REG	7 5/8REG



The ZJS type jar intensifier is a kind of down hole fishing jar designed to increase jarring energy to top jar. Therefore, it must be run in conjunction with YSJ type hydraulic top jar or CSJ type super jar. Its main function is to supply acceleration to the upper end of the jar during the free jarring stroke. With a special function, the intensifier is essentially a fluid spring which not only can accelerate the top jarring action but also make the jarring action directly to strike on the fish and reduce damages to the drill tool and fishing tool.

## Working Principle

When it is used, the jar intensifier is connected on the top of drill collar and on the lower end of drill stem. When the fishing tool engage the fish and the drill tool is lifted up, the silicone oil in the top chamber of piston is compressed and a large number of energy is thus stored. During lifting, when top jar reach up to free impact stroke, the stored energy in the jar intensifier will suddenly release, the energy suddenly released will provide a very large acceleration for drill collar and top jar to move upward. When the top jar reaches up to max. stroke, a strong top jarring action will impact directly on the fish, as a result, one time jarring is produced, and more times jarring will be effected by repeating this course.

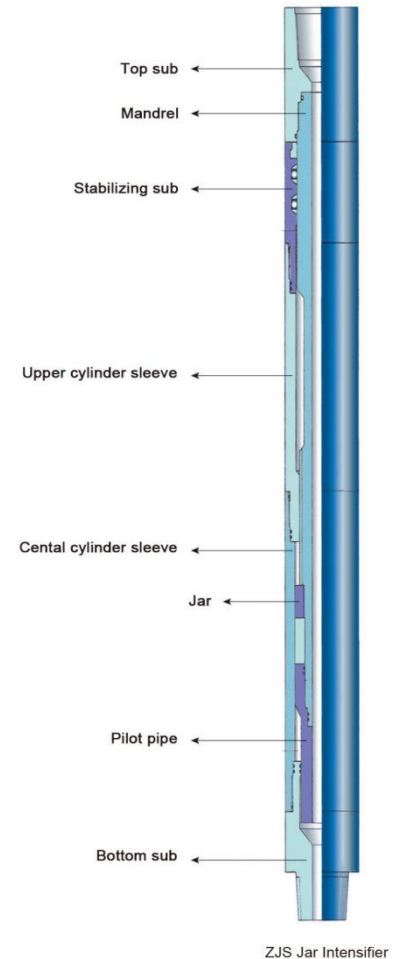

ZJS Jar Intensifier

## Specifications - ZJS Jar Intensifier

Model	ZJS31B	ZJS34B	ZJS36B	ZJS42B	ZJS44B	ZJS46B	ZJS62B	ZJS64B	ZJS70B	ZJS76B	ZJS80B	ZJS90B
O.D.in (mm)	79	89	95	108	114	121	160	165	178	197	203	229
I.D.in (mm)	25 2/5	28	28	38	38	38	57	57	57	71.4	71.4	76
Stroke in (mm)	215	215	215	250	250	250	330	330	310	330	330	330
Connecting	2 3/8REG	NC26	NC26	NC31	NC31	NC38	NC50	NC50	NC50	6 5/8REG	6 5/8REG	7 5/8REG
Max. Tension Downhole (KN)	300	400	550	700	800	900	1500	1500	1800	2100	2200	2500
Max. Work Torque (KN-m)	3	3.5	4	6	7	8	15	15	17	20	20	22
sealing pressure (MPa)	30											
Pull down full stroke force (tf)	13~15	16~19	17~20	25~30	25~30	30~35	60~65	60~65	75~85	62~67	62~67	75~85

KXJ type bumper jar (hereinafter called as bumper jar) is a mechanical jarring tool. It can make jar repeatedly the stuck drill stem to free from stuck point. When stuck drill stem can not be released by lifting and jarring, the bumper jar can be rotated to make releasable fishing tool to release fish. When used with mechanical internal cutter, it can provide an expected feeding force to the internal cutter so as to cutting steadily. When used with reversing unit, it can compensate the rising stroke for threads after reversing.

## Working Mechanism

### Energy conversion in jarring operation

Jarring downward is made by means of energy conversion. Raising drill stem shall make bumper jar to be pull down at a certain height to produce potential energy. Go on raising drill stem, the drill stem has a strain energy due to spring strain. When drill stem is lowered suddenly, the energy stored in drill stem force the drill stem to move downward in acceleration. When bumper jar reach a closed position, the above two energies at this instant change into large downward jarring force.

### Main factors having influence on jarring force

The bigger hanging weight on top drill stem of bumper jar makes a bigger jarring force;

The longer the spring extension of drill stem is when raising drill stem, the bigger the jarring force is;

The longer the stroke of the bumper jar is, the bigger the jarring force of jar is.

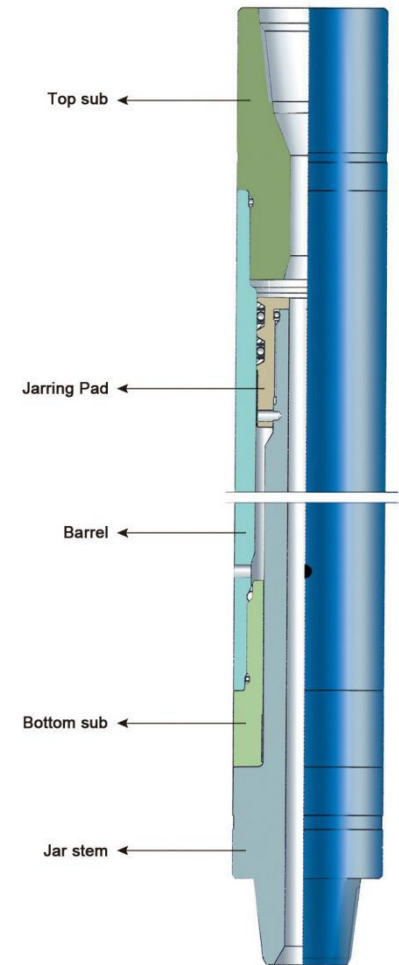

KXJ Fishing Bumper Sub

## Specifications - KXJ Type Fishing Bumper Sub

Model	KXJ31B	KXJ34B	KXJ36B	KXJ42B	KXJ46B	KXJ62B	KXJ64B	KXJ70B	KXJ76B	KXJ80B	KXJ85B	KXJ90B
OD in (mm)	79	89	95	108	121	159	165	178	197	203	219	229
ID in (mm)	25.4	28	32	38	38	51	51	70	70	70	76	76
sealing pressure (MPa)	30											
Max. Tensile Load (KN)	300	400	500	700	1200	1430	1430	1530	1630	1630	1630	2200
Max. Working Torque (KN·m)	3	3.5	4	6	8	13	13	15	20	20	20	25
Work stroke in (mm)	20	20	20	20	39 3/8	55 1/8	55 1/8	55 1/8	59	59	20	59
	508	508	508	508	1000	1400	1400	1400	1500	1500	508	1500
API connection	2 3/8REG	NC26	NC26	NC31	NC38	NC50	NC50	NC50	6 5/8REG	6 5/8REG	6 5/8REG	7 5/8REG

Lubricated fishing bumper sub is one of the jars which produce jarring force by means of the energy caused by heavy weight objects when moving down, its inner chamber is full of hydraulic oil so as to ensure a longer service life. The tool is suitable for deep hole and middle deep hole operation. With some advantages: Can produce strong one way down jarring force, maximum jarring force, continuous down jarring force. Medium jarring force; continuous up jar, **low-grade** jarring force; can release fishing tool; can act as constant pressure drill tool, simply structure, easy operation, all these make it widely used jarring tool.

## Working Principle

### Energy conversion in jarring operation

Downward is made by means of conversion. **Raising** drill stem shall make bumper jar to be pulled down at a certain height to produce potential energy. Go on raising drill stem, the drill stem has a strain energy due to spring strain. When drill stem is lowered suddenly, the energy stored in drill stem the force the drill stem to move downward in acceleration. When bumper sub reaches a closed position, the above energies at this instant change into a large downward jarring force.

### Main factors having influenced on jarring force.

Many factors influence on jarring force, but key factors as follows:

1. The bigger hanging weight on top drill stem of bumper jar makes a bigger jarring force.
2. The longer the spring extension of drill stem is when raising drill stem, the bigger the jarring force is.
3. The longer the stroke of the bumper jar is, the bigger the jarring force of jar is.

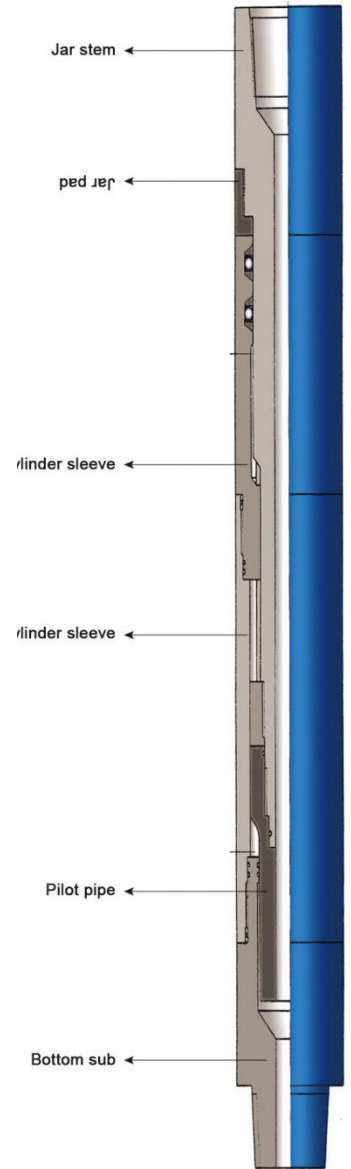

BXJ Lubricated fishing bumper sub

## Specifications - BXJ Lubricated fishing bumper sub

Model	BXJ31B	BXJ34B	BXJ36B	BXJ42B	BXJ46B	BXJ62B	BXJ64B	BXJ70B	BXJ80B
OD in (mm)	80	89	95	108	121	159	165	178	203
ID in (mm)	25.4	25.4	28	38	38	57	57	70	76.2
sealing pressure (MPa)	30								
Max.Tensile Load (KN)	30	40	50	70	90	143	143	153	220
Work stroke in (mm)	15 1/2	15 1/2	15 1/2	15 1/2	15 3/4	18 1/8	18 1/8	18 5/16	18 5/16
	394	394	394	394	400	460	460	465	465
API connection	2 3/8REG	NC26	NC26	NC31	NC38	NC50	NC50	NC50	6 5/8REG

YSJ type hydraulic up jar is **used** to be free from drilling sticking, through hydraulic principle, by means of elastic **potential** produced from drill tool elastic deformation. Once the elastic potential energy is released, it would produce a large up striking load to reach a purpose of fishing and coring. It features easy structures, strong jarring force, easy to return, convenient operation. If it is used with ZJS type jar intensifier, it may gain better jarring effect.

## Working Principle

The key principle is: the piston moves up and make hydraulic so that it makes enough time to make drill tool to save energy. With the piston continue to move slowly to releasing bore, after the binding of hydraulic oil is released, elastic potential is released by drill tool saved, immense dynamic loading is passed to drill tool due to jar pad's hitting on the bottom of upjar cylinderliner. A desire return mechanism makes a reciprocating jarring action.

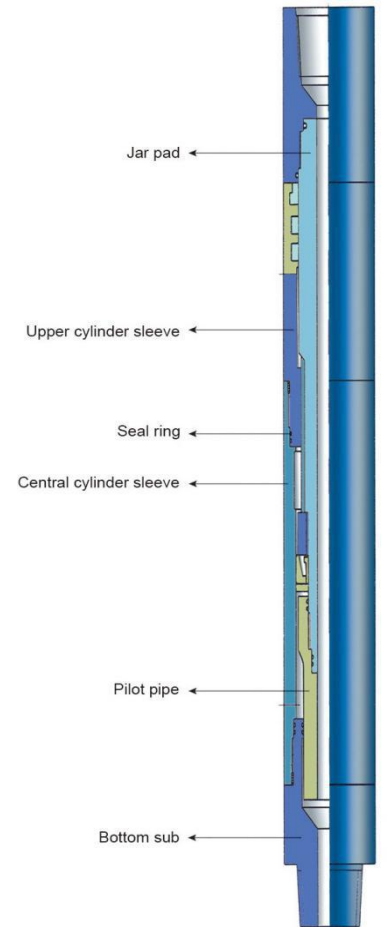

YSJ Type Z Oil Jar

## Specifications - YSJ Type Z Oil Jar

Model	YSJ95B	YSJ108B	YSJ121C	YSJ159C	YSJ178C	YSJ203C	YSJ229B
OD in (mm)	95	108	121	159	178	203	229
ID in (mm)	28	32	38	57	57	76	76
Work stroke in (mm)	245	254	330	380	380	380	380
Max. Working Torque (KN·m)	4	4.5	7.8	15	19.6	22	25
Max. jarring lifting tons (KN)	160	180	300	600	650	800	900
sealing pressure (MPa)	30						
Ambient temperature (°C)	150						
Connection	NC26	NC31	NC38	NC50	NC50	6 5/8REG	7 5/8REG

The surface jar is an effective tool for resolving the problem of drill tool stuck in down hole. It is connected with the surface section of drill string, the device to adjust the tonnage shall protrude from the rotary disc face, the violent down jarring to the stuck catch can be clearly seen when the surface jar makes jarring operation. The jarring strength for the tool can be easily adjusted and it is an easy operated, unique designed tool which can make continuous down jarring. The surface jar, which not only can bear heavy load and strong torque but also owns a good sealing property and can withstand the mud circulation with high pump pressure, has proven to be a safe, successfully effective releasing tool through many years using.

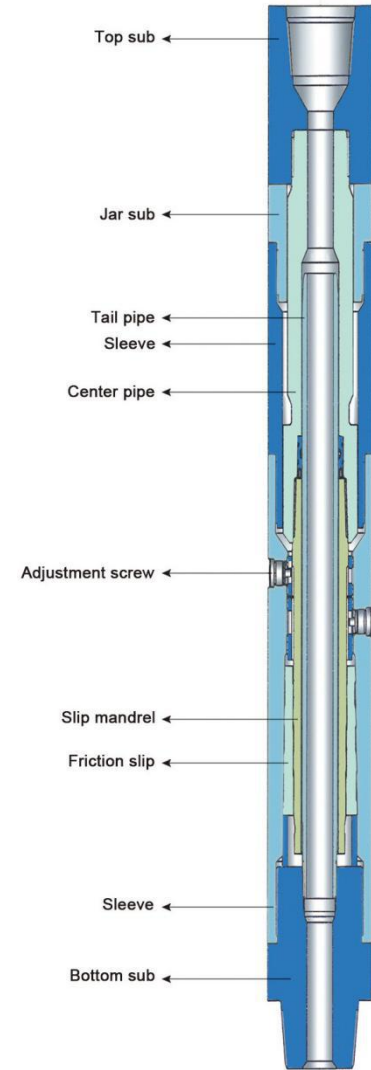

DJ Surface Bumper Jar (02)

## Specifications - DJ Surface Bumper Jar

Model	DJ46B	DJ70B	DJ70C	DJ80B
OD in (mm)	121	178	178	203
ID in (mm)	30	47	47	50
Stroke in (mm)	1500	1220	1800	2000
Max. jarring force KN	400	680	680	680
Max. Tension Load KN	1200	1500	1500	2100
sealing pressure Mpa	30			
Connection	NC38	NC50	NC50	NC50
Original releasing force (KN)	150	200	200	200

TIANHE Series 150 Releasing and Circulating Overshot is an external fishing tool for engage, pack off and retrieve tubular fish, especially for fishing drill collar and drill pipe. The grapple of the overshot can be designed for different sizes of fish, so one overshot can be dressed with different size of grapple components for fishing different sizes of fish.

### Construction

TIANHE Series 150 Overshot consists of three outside parts: Top Sub, Bowl, and Standard Guide. The Basic Overshot may be dressed with either of two sets of internal parts, if the fish diameter is near the maximum catch of the Overshot, a Spiral Grapple, Spiral Grapple Control, and Type "A" Packer are used. If the fish diameter is considerably below maximum catch size ( $\frac{1}{2}$ " or more) a Basket Grapple and a Mill Control Packer are used.

### When ordering please specify:

- The model of the overshot
- The hole, casing size or O.D. of overshot
- Top connection
- O.D of the fish

FS = Full Strength  
SH = Slim Hole

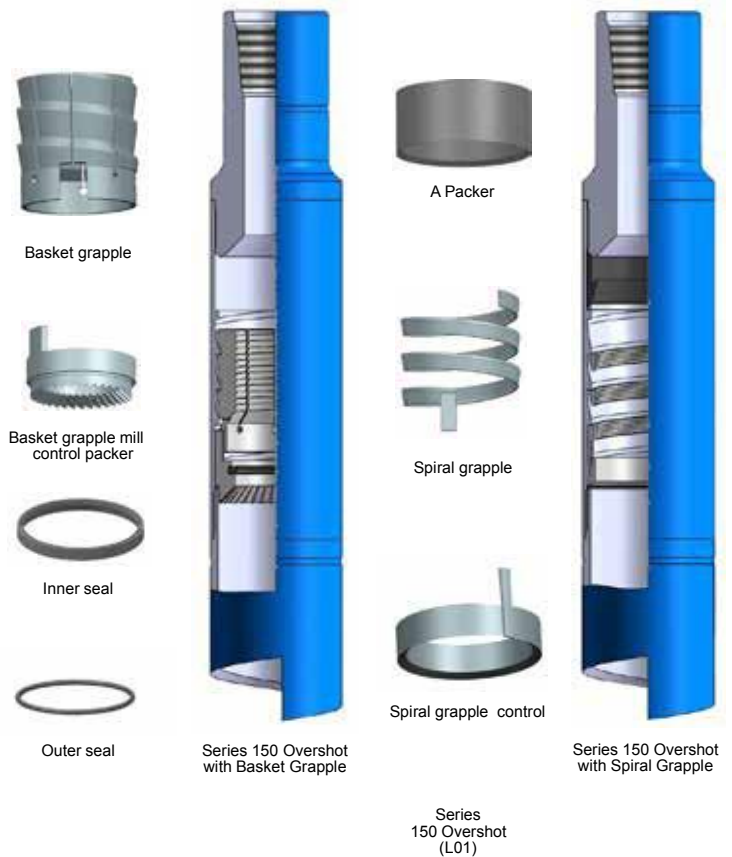

## Specifications - Series 150 Overshot

Model	Product Code	O.D (mm)	Max.Catch Size(mm)		API Connection	Model	Product Code	O.D. (mm)	Max.Catch Size (mm)		API Connection
			Spiral Grapple	Basket Grapple					Spiral Grapple	Basket Grapple	
LT-T89F.S.	L01-1100	89	60.3	48.3	NC26	LT-T200F.S.	L01-2500	200	159	141	NC50
LT-T98S.H.	L01-4600	98	79.4	66.7	NC26	LT-T200S.H.	L01-5500	200	171.5	155.6	NC50
LT-T102F.S.	L01-1300	102	73	60.3	NC26	LT-T206S.H.	L01-2700	206	178	163	NC50
LT-T114S.H.	L01-1500	114	89	73	NC31	LT-T206F.S.	L01-2600	206	165	149	NC50
LT-T119S.F.S.	L01-6000	119	95.3	82.6	NC31	LT-T210F.S.	L01-5100	210	168	149	NC50
LT-T121S.H.	L01-6100	121	98.4	85.7	NC31	LT-T232S.H.	L01-3000	232	203	187	NC50
LT-T138F.S.	L01-6400	138	105	89	NC38	LT-T245F.S.	L01-3100	245	203	184	6 5/8REG
LT-T143S.H.	L01-1700	143	121	108	NC38	LT-T257F.S.	L01-5200	257	216	197	6 5/8REG
LT-T146F.S.	L01-1800	146	121	108	NC38	LT-T270F.S.	L01-3300	270	228.6	209.6	6 5/8REG
LT-T149S.H.	L01-1900	149	127	114	NC38	LT-T286F.S.	L01-3500	286	244.5	225.4	6 5/8REG
LT-T168S.H.	L01-2200	168	139.7	120.6	NC50	LT-T298F.S.	L01-3600	298	257	238.1	6 5/8REG
LT-T181F.S.	L01-2300	181	146	127	NC50	LT-T324	L01-4300	324	286	267	6 5/8REG
LT-T194S.F.S.	L01-2400	194	159	141	NC50	LT-T350	L01-4400	350	305	286	6 5/8REG



TIANHE Series 150 Releasing and Circulating Overshot can be equipped with a wide range of accessories to meet a variety of complex fishing environmental.

### Extension Sub

An extension sub is assembled between the top sub and the bowl. It is used when the upper portion of the fish is damaged or cannot be engaged. This accessory will permit the overshot to be lowered far enough over the fish to ensure secure engagement and pack off. They are available in lengths from 24 to 60 inches. When ordering, specify overshot O.D. Unless otherwise specified. Extension Subs will be furnished in a standard 36-inch length.



Extension Sub



Wall Hook Guide

### Wall Hook Guide

If the fish is positioned in a washed out section of the hole, it may be difficult to engage the top of the fish using a conventional overshot guide. A wall hook guide can be used to capture the neck of the fish, centralize it, and then properly guide the fish into the bowl.

### Oversize Guide

Oversized Guide properly guides the fish into the overshot when the hole size is considerably larger than the diameter of the fish and the overshot may pass alongside the fish without engaging it. Installation of an oversized guide instead of a standard guide will ensure alignment of the fish with the overshot.



Oversize Guide

### Mill Extension

Overshot Mill Extension interiors are faced with incoloy to a size that will mill away a flared or jagged fish to enable it to pass up into and be engaged by the Grapple in the Bowl. Mill Extensions are installed between the Bowl and the standard, oversized or wall hook guides.

### Mill Guide

Overshot Mill Guides are designed to remove badly flared or jagged metal from the top of the fish. Mill Guides are used in place of the Standard or Oversized Guide to trim the fish so it can enter the overshot.

Mill Guide



Mill Extension

The TIANHE Series 70 Short Catch Overshot is an external fishing tool designed to retrieve tubular fish when the top of the fish is too short to be engaged with other overshot. The Grapple Control is positioned above the Basket Grapple rather than below it to allow the Basket Grapple to occupy the lowest position in the Bowl. This enables the overshot to firmly engage and retrieve a very short fish.

### Construction

The TIANHE Series 70 Short Catch Overshot assembly consists of a Top Sub, Bowl, Basket Grapple Control, and a Basket Grapple. Although the Series 70 Overshot has no Guide, the components function in the same manner as the standard Series 150 Releasing and Circulating Overshot.

### Catching the Fish

Attach the Overshot to the bottom end of the fishing string and run it into the hole. Series 70 Overshot assembly is rotated to the right and lowered as the fish enters the expandable grapple. With the fish in the grapple, stop right-hand rotation and exert an upward pull to fully capture the fish.

### Releasing the Fish

A sharp downward force (bump) is applied to the Overshot to break the hold of the grapple within the bowl. The Overshot is then rotated to the right while it is slowly elevated to release the grapple from the fish.

### When ordering please specify:

The model of the overshot.

The hole, casing size or O.D. of overshot

Top connection

O.D of the fish

note: We can design Overshot according to customers' request

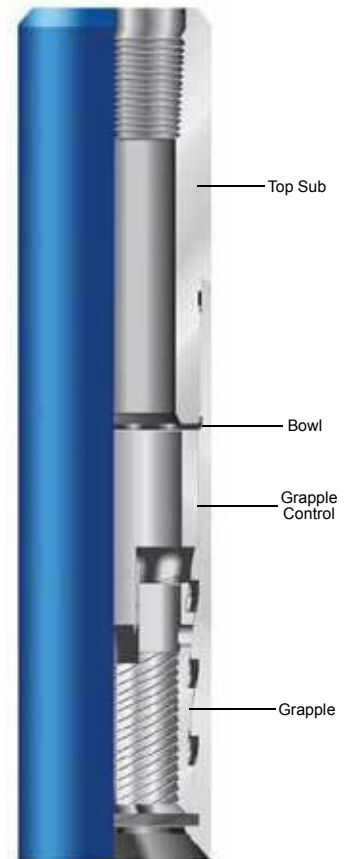

Series 70 Short Catch Overshot (L04)

### Specifications - Series 70 Short Catch Overshot

Model	O.D. (mm)	Max. Fishing Size (mm)	Connection Box	Type	Product Code
DYLT-T59	59	41.3	7/8Rod	S.H.	L04-5910
DYLT-T81	81	60.3	2 3/8NU		L04-8110
DYLT-T92	92	63.5	NC26	S.H.	L04-9210
DYLT-T95	95	66.6	NC26	S.H.	L04-9510
DYLT-T100	100	77.7	NC26	S.H.	L04-10010
DYLT-T105	105	77.7	NC26	S.H.	L04-10510
DYLT-T111	111	85.7	NC31	S.H.	L04-11110
DYLT-T114	114	82	NC31		L04-11410
DYLT-T117	117	77.7	NC31	F.S.	L04-11720
DYLT-T119A	119	92.8	NC31	S.H.	L04-11910
DYLT-T121	121	95.2	NC38	S.H.	L04-12110
DYLT-T133	133	104.8	NC38	F.S.	L04-13310
DYLT-T140	140	95.2	NC38	F.S.	L04-14010
DYLT-T143	143	92.8	NC38	F.S.	L04-14310
DYLT-T146	146	108	NC38	F.S.	L04-14610
DYLT-T150	150	120.6	NC38	S.H.	L04-15000
DYLT-T159	159	133.3	NC38	S.H.	L04-15910
DYLT-T161	161	133.3	NC38		L04-16110
DYLT-T168	168	120.7	NC38	F.S.	L04-16810
DYLT-T194	194	152.4	NC50	F.S.	L04-19410
DYLT-T200	200	158.7	NC50	F.S.	L04-20000
DYLT-T203	203	162	NC50	F.S.	L04-20310
DYLT-T206	206	162	NC50		L04-20610
DYLT-T210	210	165.1	NC50	F.S.	L04-21000
DYLT-T210A	210	159	NC50		L04-21020
DYLT-T213	213	177.8	NC50	S.H.	L04-21310
DYLT-T216	216	177.8	NC50	F.S.	L04-21610
DYLT-T235	235	196.8	6 5/8REG	F.S.	L04-23510
DYLT-T247	247	203.2	6 5/8REG	F.S.	L04-24700
DYLT-T254	254	209.6	6 5/8REG	F.S.	L04-25400
DYLT-T286	286	228.6	6 5/8REG	F.S.	L04-28600

TIANHE Series 10 Sucker Rod Overshot is a professional fishing tool, designed for engaging and retrieving sucker rods, couplings, and other tubular from inside tubing strings.

TIANHE Series 10 Sucker Rod Overshot consists of a Top Sub, Bowl, Grapple, and a Guide. According to the size of the fish, there are two types of grapples available: Basket Grapple or Spiral Grapple. TIANHE Series 10 is a simply tool to use, no matter engaging or releasing operation, in fact just need to rotate the fishing string on right hand.

#### Engaging a Fish

When overshot nears the top of the fish, slowly rotate to the right as the overshot is lowered over the fish. After the fish is engaged, allow right-hand torque to release from the fishing string. Then raise the fish by pulling upward on the fishing string.

#### Releasing a Fish

Bump down or drop the weight of the fishing string against the Overshot to break the hold of the grapple within the bowl. Elevate the fishing string while slowly rotating it to the right until the Overshot has cleared the fish.

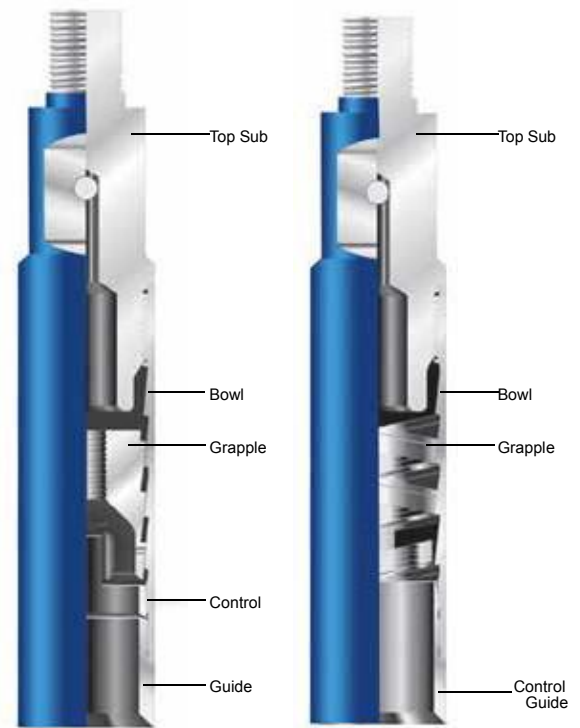

Series 10 Overshot with Basket Grapple

Series 10 Overshot with Spiral Grapple

Series 10 Overshot (L03)

## Specifications - SERIES 10 OVERSHOT

MAXIMUM CATCH Spiral (in) / (mm)	1.0625	1 1/2	1 5/8	1 3/4	1 15/16	1 13/16	2	2 3/8
	-27	-38.1	-41.3	-44.5	-49.2	-46	-50.8	-60.3
MAXIMUM CATCH Basket (in) / (mm)	43289	1 5/16 (33.3)	1 7/16 (36.5)	1 9/16	1 3/4 (44.5)	1 5/8	1 13/16	2 3/16
	-22.2			-39.7		-41.3	-46	-55.6
OVERSHOT O.D. (in) / (mm)	1.5625	1 25/32	1 29/32	2 1/16	2 1/4	2 5/16	2 5/16	2 27/32
	-39.7	-45.2	-48.4	-52.4	-57	-58.7	-58.7	-72.2
TYPE	S.H.	S.H.	S.H.	S.H.	S.H.	F.S.	S.H.	S.H.
CONNECTION (PIN)	3/4Rod	3/4Rod	3/4Rod	3/4Rod	7/8Rod	7/8Rod	7/8Rod	1Rod
COMPLETE ASSEMBLY Part No.	L03-1100	L03-1400	L03-1500	L03-1800	L03-2100	L03-2000	L03-2300	L03-2600

## SERIES 20 OVERSHOT

TIANHE Series 20 Short Catch Sucker Rod Overshots are designed for conditions when sucker rods, couplings, and other portions of a fish are too short for retrieval with a standard overshot. ■

The TIANHE Series 20 Short Catch Sucker Rod Overshot consists of a Top Sub, Bowl, Basket Grapple Control, and a Basket Grapple. The Grapple Control is located at the top end of the tool between the Top Sub and the Basket Grapple. The position of the Grapple Control above the Basket Grapple rather than below it allows the Basket Grapple to occupy the lowest position in the bowl.

This permits the exposed part of the fish to enter the Basket Grapple where it can be firmly and securely grasped. Operation of the TIANHE Series 20 Short Catch Sucker Rod Overshot is the same as the TIANHE Series 10 Sucker Rod Overshot.

MODEL	O.D.(in/mm)	Max catch size(in/mm)	connection	TYPE	CODE
DYLT-TC32	1 1/4	7/8	5/8Rod		L22-3210
	-32	-22.2			
DYLT-TC35	1 3/8	1	5/8Rod		L22-3510
	-35	-25.4			
DYLT-TC38	1 1/2	1 1/8	3/4Rod		L22-3810
	-38	-28.6			
DYLT-TC41	1 5/8	1 1/4	3/4Rod		L22-4110
	-41.3	-31.8			
DYLT-TC45	1 3/4	1 3/8	3/4Rod		L22-4510
	-45	-34.9			
DYLT-TC47	1 27/32	1 3/8	3/4Rod		L22-4710
	-47	-34.9			
DYLT-TC47A	1 27/32	1 15/32	3/4Rod		L22-4720
	-47	-37.3			
DYLT-TC49A	1 29/32	1 1/2	3/4Rod	S.H.	L22-4910
	-49	-38.1			
DYLT-TC49	1 15/16	1 3/8	3/4Rod		L22-4920
	-49.2	-34.9			
DYLT-TC57	2 1/4	1 3/4	7/8Rod		L22-5710
	-57.2	-44.5			
DYLT-TC59	2 5/16	1 5/8	7/8Rod		L22-5910
	-59	-41.3			
DYLT-TC59A	2 5/16	1 13/16	7/8Rod	S.H.	L22-5920
	-59	-46			
DYLT-TC71	2 25/32	2 1/8	7/8Rod		L22-7110
	-71	-54			
DYLT-TC72	2 53/64	2 3/16	1Rod		L22-7210
	-72	-55.6			
DYLT-TC73A	2 7/8	2 1/8	1Rod		L22-7310
	-73	-54			
DYLT-TC73	2 7/8	2 5/16	1Rod	S.H.	L22-7320
	-73	-58.7			
DYLT-TC80	3 1/8	2 3/8	2 3/8NU		L22-8010
	-80	-60.3			
DYLT-TC83	3 1/4	2 1/2	2 3/8NU		L22-8310
	-83	-63.5			
DYLT-TC86	3 3/8	2 5/8	2 3/8NU		L22-8610
	-86	-66.7			

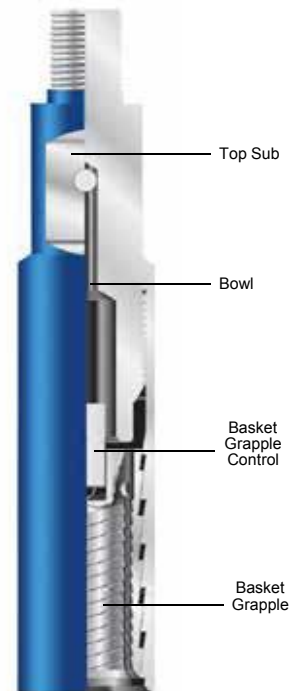

Type DLT-T Releasable Reversing Overshot, a new type of fishing tool, has many advantages owned by various overshot, box tap and the like. Its distinguishing features are as follows: to unscrew and recover the stuck fish; To release the fish down hole if necessary; to circulate the washing fluid as one of the accessories for reversing tools. It is widely used in well servicing.

### Structure and Application

Consisting of top sub, spring, bowl, retaining seat, slip, control key, seal ring, seal seat, guide and so on. The upper end of top sub is connected with other tools and drill tool. The lower end of top sub is connected with bowl equipped with spring in the interior. There are three control keys uniformly distributed in the inner wall of the upper end of bowl. the control keys are used to control the position of retaining seat. Three keys are inserted separately in three grooves in the tapered interior section of lower end in bowl where three keys are used to transmit torque. The tapered interior section produces a pinch force against the slip to trigger the fishing operation. The inclined angle among three control keys play an important role in retaining conformance of the slip with the bowl to ensure that the tools can be released easily from the fish.

The retaining seat is installed at the upper end of the external bowl where the three keys are placed. The retaining seat not only can slide axially, but also rotates round the axial line moving with the slip which is installed in the internal circular recess.



Releasing and Reversing  
Overshot  
(L07)

### Specifications - Table 1 Releasing and Reversing Overshot Connection LH

Model	O.D. (mm)	Max. Fishing Size (mm)	Allowed Pull (KN)	Releasing Pull & Allowed Torque		Connection (Box LH)	Product Code
				Pull (KN)	Torque (N.m)		
DLT-T95×48	95	48.3	250	120	3100	2 7/8 REG	L07-4800
DLT-T105×60	105	63.5	350	150	5750	NC31	L07-6000
DLT-T114×73	114	78.6	420	180	7750	NC31	L07-7300
DLT-T134×89	134	93.2	500	180	10250	NC38	L07-8900
DLT-T145×102	145	101.6	700	200	11050	NC38	L07-10200
DLT-T160×114	160	114.3	900	200	12150	NC38	L07-11400
DLT-T185×127	185	127	1200	240	13500	NC50	L07-12700
DLT-T200×140	200	139.7	1500	240	15300	NC50	L07-14000

### Specifications - Table 2 Releasing and Reversing Overshot connection RH

Model	O.D. (mm)	Max. Fishing Size (mm)	Allowed Pull (KN)	Releasing Pull & Allowed Torque		Connection (Box LH)	Product Code
				Pull (KN)	Torque (N.m)		
DLT-T105×60F	105	63.5	350	150	5750	NC31	L07-6010
DLT-T114×73F	114	78.6	420	180	7750	NC31	L07-7310
DLT-T134×89F	134	93.2	500	180	10250	NC38	L07-8910
DLT-T160×114F	160	114.3	900	200	12150	NC38	L07-11420

Lifting-Lower and releasing overshot is a fish tool in the casing which fishes fractured tubing and drill string. If fish drill string is stuck heavily and hard to complete fishing work, while need to release fish, may get back the tool by bumping drill string down and lift directly.

The product is excellent for fishing operations as it does not require rotation. Fishes can be caught or released through simple lifting or lowering of the tool.

### Structure

Lifting-Lower and Releasing Overshot is composed of top sub, bowl, guide pin, guide sleeve, joint sleeve, plug, roller pin, slip, guide, as shown in the figure. The box thread of top sub is connected with drill stem and the pin thread is connected with the bowl. The bottom of bowl is connected to the guide. An inner cone in the bowl matches the slip. Box thread of guide sleeve is connected with joint sleeve, track trenches are milled on another outer surface: three long trenches and three short trenches act as guiding and reversing. When guide pin locates in long trench is in the condition of fish. When guide pin locates in short trench is in the condition of release. Joint sleeve is two petals formation. It makes slip and guide sleeve connection and by roller pin act as bearing. The inner surface of slip has fish thread, guide is on the bottom and can make fish introduce into slip successfully.

### Working Principle

The tool complete fishing and releasing fish through long, short track trenches. When the tool reaches the top of fish, it is lowered and is in contact with the fish. Through lifting and lowering, guide pin is in the position of long or short trench, slip is in the situation of fishing or releasing, in the condition of non-rotating complete fishing and releasing fish.

### Specifications - Lifting-Lowering and Releasing Overshot



Lifting-Lowering and Releasing Overshot (L05)

Model	Product Code	O. D.(mm)	Connection	Catch Size (in)
TFLT48	L05-4800	95	NC26	1.9
TFLT60	L05-6000	105	NC31	2 3/8
TFLT73	L05-7300	115	NC31	2 7/8
TFLT89	L05-8900	134	NC38	3 1/2
TFLT114	L05-11400	150	NC38	4 1/2

TIANHE Releasing Spear provide a more effective means to engage and retrieve an internal fish from the well. It is ruggedly built to withstand severe jarring and pulling strains. It engages the fish over a large area without damaging of the fish. The simple design prevent small parts being lost or damaged in the hole during operation. It may be used with other equipment such as pack-off assemblies and internal cutters. If the fish cannot be pulled, the spear can be easily be released and disengaged.

### Construction

The Releasing Spear consists of a mandrel, grapple, releasing ring, and a bull nose nut. The mandrel is made of specially heat treated high strength alloy steel; and may be ordered either as a flush type to enter completely into a fish or as a shoulder type to provide a positive landing position on top of the fish. Size and type of the upper box connection can be customized provide according to customer's exact specification.

### When ordering please specify:

- The model of the releasing spear.
- Top connection
- The exact size and weight of the fish
- Flush or shoulder type mandrel

### Specifications-Releasing Spear LM-T

Model	Nut O.D. ( mm )	Catch size ( in )	I.D ( mm )	Code
LM-T48	35	1.9	8	L02-100
LM-T60	45	2 3/8	8	L02-110
LM-T73	54	2 7/8	10	L02-120
LM-T89	66	3 1/2	10	L02-130
LM-T102	76	4	16	L02-140
LM-T114	88	4 1/2	16	L02-150
LM-T127	98	5	25	L02-160
LM-T140	108	5 1/2	30	L02-170
LM-T168	130	6 5/8	30	L02-180
LM-T178	145	7	50	L02-190
LM-T219	174	8 5/8	71	L02-210
LM-T245	174	9 5/8	71	L02-220
LM-T273	210	10 3/4	71	L02-230
LM-T273-1	222	10 3/4	71	L02-260
LM-T340	210	13 3/8	71	L02-250
LM-T340-1	222	13 3/8	71	L02-240

### Specifications-Releasing Spear LM-B

Model	Nut O.D. ( mm )	Catch size ( in )	I.D(mm)	Code
LM-T48-B	35	1.9	8	L02-4810
LM-T60-B	47	2 3/8	10	L02-6010
LM-T73-B	58	2 7/8	10	L02-7310
LM-T89-B	71	3 1/2	12	L02-8910
LM-T102-B	82	4	16	L02-10210
LM-T114-B	92	4 1/2	19	L02-11410
LM-T127-B	98	5	22	L02-12710
LM-T140-B	108	5 1/2	25	L02-14010
LM-T168-B	130	6 5/8	25	L02-16810
LM-T178-B	145	7	50	L02-17810
LM-T219-B	174	8 5/8	71	L02-21910
LM-T245-B	174	9 5/8	71	L02-24510
LM-T273-B	210	10 3/4	71	L02-27320
LM-T273-B1	222	10 3/4	71	L02-27330
LM-T340-B	210	13 3/8	71	L02-34020

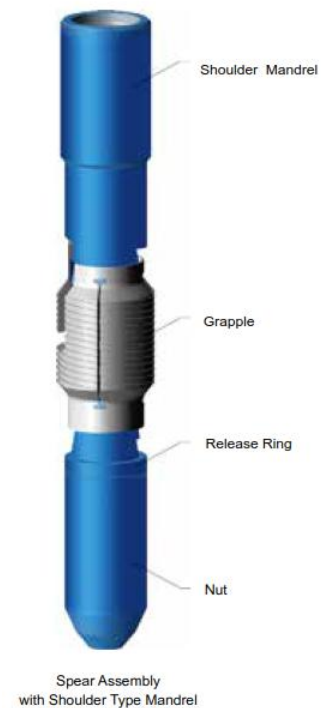

Spear Assembly with Shoulder Type Mandrel

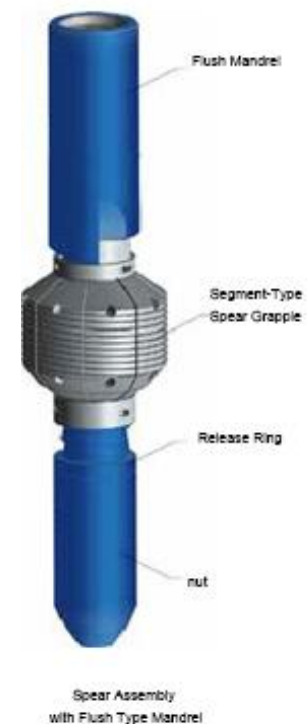

Spear Assembly with Flush Type Mandrel



### Segment-Type Spear Grapple

The Segment-Type Spear Grapple enhances the spear's effectiveness by providing an extended catching range beyond the maximum range of the standard one-piece grapple. TIANHE Segment-Type Spear Grapple is used in place of the standard one-piece Grapple on the 9 5/8" Spears. This enhances the spear's capability of engaging up to 20".

Segment-Type Spear Grapple consists of a grapple body, eight grapple segments, two retainer rings, six retainer ring screws, six retainer ring spacers, and sixteen grapple segment screws.



Segment-Type  
Spear Grapple

### Pack-off Assembly

Pack-off Assembly is available for all TIANHE Spear Assemblies and is designed to efficiently pack-off all sizes of tubing and casing. Circulation through the fish is enabled by attaching the Spear Pack-off Assembly to the bottom of the spear with a sub type nut.

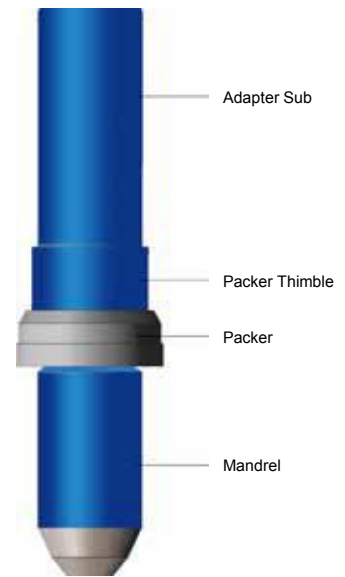

Spear Pack-off Assembly

### Spear Stop Sub

The TIANHE Releasing Spear Stop Sub Assembly is an accessory designed to convert a releasing spear with a flush-type mandrel into a shouldered type spear. It is installed in the box connection at the top of the mandrel when the use of a positive stop is desired or required. A stop ring can be added to increase shoulder diameter. All stop rings are furnished with left-hand threads.

### Optional Nuts

Mill Type to mill away burrs, Sub Type to connect and run other tools below the Spear, and Sidehill Type to center the spear in greatly oversize holes to assure entry of the Spear into the fish.



Sub Type nut



Mill Type nut



Sidehill Type nut



Stop Sub



Stop Ring

The reversing subs is also called reversing spear which is a special tool for reversing stuck drill stem above stuck point in drilling and workover operation. In treatment of stuck drill stem, it can work as a fishing pin tap in reversing operation. When fish is stuck or cannot be reversed in fishing or reversing operation, the fish can be reversed from reversing sub and the fishing drill tool is tripped out.

### Specifications - Reversing Sub

表 1 DKJ 型倒扣接头（接头螺纹左旋、打捞螺纹右旋）

Model	O.D (mm)	I.D. (mm)	Thread Conn (LH)	Fishing Thread (RH)	Product Code
DKJ105	105	14	NC31	NC31	L08-10500
DKJ105	105	18	NC31	2 7/8 NU	L08-10510
DKJ121	121	20	NC38	NC38	L08-12100
DKJ140	140	20	NC40	NC40	L08-14000
DKJ159	159	28	NC46	NC46	L08-15900
DKJ165	165	28	NC50	NC46	L08-16500
DKJ165	165	28	NC50	NC50	L08-16510
DKJ165	165	32	NC50	5 1/2 FH	L08-16520
DKJ178	178	32	5 1/2 FH	5 1/2 FH	L08-17800
DKJ190	190	32	NC50	6 5/8 REG	L08-19000
DKJ203	203	32	NC50	NC61	L08-20300
DKJ203	203	32	NC50	6 5/8 FH	L08-20310
DKJ203	203	32	NC50	7 5/8 REG	L08-20320



Reversing Sub (L0)

### Specifications - Reversing Sub

表 2 DKJ 型倒扣接头（接头螺纹右旋、打捞螺纹左旋）

Model	O.D (mm)	I.D. (mm)	Thread Conn (RH)	Fishing Thread (LH)	Product Code
DKJ105A	105	14	NC31	NC31	L08-10520
DKJ121A	121	20	NC38	NC38	L08-12110
DKJ146A	146	25	4 1/2 FH	4 1/2 FH	L08-14600
DKJ168A	168	28	NC50	NC50	L08-16800
DKJ168A	168	28	NC50	NC46	L08-16810
DKJ178A	178	32	5 1/2 FH	5 1/2 FH	L08-17810
DKJ178A	178	32	NC50	NC56	L08-17820

### Specifications - Reversing Sub

表 3 DKJ 型倒扣接头（接头螺纹右旋、打捞螺纹右旋）

Model	O.D (mm)	I.D. (mm)	Thread Conn (RH)	Fishing Thread (RH)	Product Code
DKJ93B	93	18	2 7/8 EU	2 7/8 EU	L08-9300
DKJ105B	105	14	NC31	NC31	L08-10530
DKJ114B	114	28	3 1/2 EU	3 1/2 EU	L08-11400
DKJ121B	121	18	NC38	NC38	L08-12120
DKJ140B	140	20	NC40	NC40	L08-14010
DKJ165B	165	28	NC50	NC46	L08-16530
DKJ165B	165	28	NC50	NC50	L08-16540
DKJ178B	178	32	5 1/2 FH	5 1/2 FH	L08-17830
DKJ178B	178	32	NC50	NC56	L08-17840
DKJ210B	210	32	6 5/8 FH	6 5/8 FH	L08-21000

In drilling and workover operation, the reversing spear is a tool mainly used for fishing of drill pipe, oil pipe and casing from fish hole. It can be used with internal cutter, bumper jar, etc.

### Specifications - Reversing Spear

Model	O.D (mm)	Thread Conn (RH)	I.D (mm)	Min. Fishing size (mm)	Lead-in Diameter of Spear Rod(mm)	Code
DLM-T48	86	NC26	7	39.7	37	L10-4810
DLM-T60	105	NC31	8	49.7	46.5	L10-6000
DLM-T73	105	NC31	8	62	56	L10-7300
DLM-T89	105	NC31	16	75	71	L10-8900
DLM-T102	121	NC38	16	88.2	83	L10-10200
DLM-T114	121	NC38	16	99.8	93	L10-11400
DLM-T127	127	NC38	20	107	98	L10-12700
DLM-T140	140	NC38	25	118	107	L10-14010
DLM-T178	178	NC50	30	150.4	142	L10-17800
DLM-T245	245	6 5/8REG	70	213.5	205	L10-24500
DLM-T273	273	6 5/8REG	70	232.6	215	L10-27300
DLM-T340	340	6 5/8REG	76	313.6	253	L10-34000



Reversing Spear (L10)

The Cable Fishing Hook is generally used to catch electric pump cables or wirelines and broken pieces of the bent sucker rods in casing.

### Specifications - Cable Fishhook

Outside size (mm)	Product Code	Connection	Catch	For Casing size (in)
Φ120 x 1800	L16-14000	NC31	Electric cables	5 1/2 Casing
Φ140 x 1800	L16-16800	NC31	Electric cables	6 5/8 Casing
Φ150 x 1800	L16-17800	NC38	Electric cables	7 Casing



Cable Fishhook (L16)

### SLIDING BLOCK SPEAR

The Sliding Block Spear is an internal fishing tool used for fishing fallen objects that are generally used in oil perforation process, such as drill pipe, tubing, wash pipe, liner, packer, water distributor, etc. It can also be used for the reversing of stuck fallen objects and it can be used in conjunction with other tools such as jar and back-off tool.

### Specifications - Sliding Block Spear

Model	Product Code	O.D. (mm)	Connection (Box)	I.D. (mm)	Dia. of spear rod (mm)	I.D. of fish (mm)	O.D. of fish (in)	Length (mm)
HLM-SS60	L12-4600	121	NC38	12(Side bore)	46	49.66	2 3/8	1200
	L12-4700	79	2 3/8 REG	12(Side bore)	47	50.7		1000
HLM-SS73	L12-5100	105	NC31	12(Side bore)	51	54.6	2 7/8	1200
	L12-5500	79	2 3/8 REG	12(Side bore)	55	62		1200
	L12-5700	121	NC38	12(Side bore)	57	62		1200
HLM-SS89	L12-6500	121	NC38	15(Side bore)	65	70.2	3 1/2	1200
	L12-7000	121	NC38	15(Side bore)	70	76.2		1200
HLM-SS114	L12-8600	122	NC31	18(Side bore)	86	90-95	4 1/2	1200
	L12-8800	168	NC50	18(Side bore)	88	92.5-97.2		1200
	L12-9100	122	NC31	18(Side bore)	91	97.2-103.9		1200
HLM-SS127	L12-9700	168	NC50	18	97	101.6-116	5	1200
HLM-SS140	L12-10800	141	NC31	18	108	114.3-121.4	5 1/2	1200
	L12-11200	168	NC38	20	112	118.6-124.3		1265

note: Unless required specially, the length is 1200mm.



Sliding Block Spear (L12)

The Taper Tap is a special internal catch fishing tool that engages with dropped tubular objects such as drill pipes and tubes by tapping threads on the object surfaces. It is a highly effective tool in the fishing of dropped tubular objects with couplings especially when the tapered threads engaged with the fish couplings. The taper tap can be used for different fishing operations when equipped with left hand threaded or right hand threaded drill pipes and tools. The taper tap is made from high strength alloy steel, heat treated for maximum strength and ruggedness. The cutting threads are hardened (wicked) with cutting grooves to ensure proper tapping of threads on the fishes.

## Specifications - Taper Tap

Model	Product Code	Large wicker O.D. (mm)	Small wicker O.D. (mm)	ID (mm)	O.D.(mm)	Catch Size(in)
GZ47×28-NC26	L19-02000	47	28	10	86	1.9 Tubing
GZ60×38-NC26	L19-02001	60	38	12	86	2 3/8 Tubing
GZ70×45-NC26	L19-02002	70	45	16	86	2 7/8 Tubing
GZ86×56-NC31	L19-03000	86	56	20	105	3 1/2 Tubing
GZ98×65-NC38	L19-05000	98	65	25	121	4 Tubing
GZ110×77-NC50	L19-09000	110	77	25	168	4 1/2 Tubing
GZ62×40-NC26	L19-02003	62	40	16	86	2 3/8 Drill pipe
GZ85×60-NC31	L19-03001	85	60	25	105	3 1/2 Drill pipe
GZ109×79-NC50	L19-09001	109	79	25	168	4 1/2 Drill pipe
GZ130×95-NC50	L19-09002	130	95	38	168	5 1/2 Drill pipe
GZ160×145- NC50	L19-09003	160	145	51	168	6 5/8 Drill pipe
GZ122×92-NC50	L19-09004	122	92	38	168	5 Casing
GZ135×109-NC50	L19-09005	135	109	51	168	5 1/2 Casing
GZ162×137- NC50	L19-09006	162	137	51	168	6 5/8 Casing
GZ172×147-6 5/8REG	L19-19000	172	147	51	203	7 Casing
GZ187×161-6 5/8REG	L19-19001	187	161	51	203	7 3/4 Casing
GZ215×185-7 5/8REG	L19-20000	215	185	51	241	8 5/8 Casing
GZ237×211-7 5/8REG	L19-20001	237	211	51	241	9 5/8 Casing
GZ85×52-NC31	L19-03002	85	52	20	105	Φ76.2-Φ57.2(mm)



Taper Tap  
(L19)

The die collar, also known as skirted taper tap, is a special external fishing tool that engages with the dropped tubular objects such as drill pipes and oil tubing, by tapping on the external wall of the objects. It can be used in fishing cylindrical objects without inner bore or stuck inner bore.

The die collar is a long cylindrical integral structure composed of a Sub, a Tap body with cutter threads in the cone shaped interior. The die collar is made of high strength alloy with cutting grooves in the fishing threads.



Die Collar  
(L19)

## Specifications - Die Collar

Model	Product Code	Large wicker O.D. (mm)	Small wicker O.D. (mm)	OD(mm)	Catch size(mm)
MZ55×40-NC26	L20-02000	55	40	86	48
MZ68×50-NC26	L20-02001	68	50	95	60
MZ80×62-NC26	L20-02002	80	62	114	73
MZ96×74-NC31	L20-03000	96	74	127	89
MZ110×90-NC38	L20-05000	110	90	143	102
MZ122×102-NC38	L20-05001	122	102	162	114
MZ135×110-NC50	L20-09000	135	110	175	127
MZ148×128-NC50	L20-09001	148	128	190	140
MZ167×140-NC50	L20-09002	167	140	203	159
MZ178×153-6 5/8 REG	L20-19000	178	153	211	168
MZ190×166-6 5/8 REG	L20-19001	190	166	219	178
MZ210×185-6 5/8 REG	L20-19002	210	185	247	203
MZ239×216-7 5/8 REG	L20-20000	239	216	280	228
MZ251×229-7 5/8 REG	L20-20001	251	229	290	241



The internal hook is a fishing tool generally used inside casings and oil tubings for fishing ropes and other fishes such as wire-lines, cables, logging wire-lines and paraffin cutters.

There are two types of internal hooks for different fishing applications: Dead (fixed) hook and Live (adjustable) hook.

### Specifications - Internal Hook

Model	Product Code	O.D.(mm)	Connection	For Casing/Tubing Size(in)
NG70	L23-7000	70	2 3/8 PAC	3 1/2
NG90	L23-9000	90	NC26	4 1/2
NG110	L23-11000	110	NC31	5 1/2
NG136	L23-13600	136	NC31	6 5/8
NG150	L23-15000	150	NC38	7
NG176	L23-17600	176	NC38	8 5/8
NG190	L23-19000	190	NC38	9 5/8



Internal Hook (L23)

The External Hook is used inside casings and tubings to catch all kinds of ropes, lifting bails, hollow short cylinders, short rope slings such as wire-lines, logging steel pieces, cables, etc.

### Specifications - External Hook

Model	Product Code	O.D.(mm)	Connection	For Casing/Tubing Size(in)
WG70	L24-7000	70	2 3/8 PAC	3 1/2
WG90	L24-9000	90	NC26	4 1/2
WG110	L24-11000	110	NC31	5 1/2
WG136	L24-13600	136	NC31	6 5/8
WG150	L24-15000	150	NC38	7
WG176	L24-17600	176	NC38	8 5/8
WG190	L24-19000	190	NC38	9 5/8



External Hook (L24)

TIANHE Reverse Circulation Junk Basket (RCJB) is designed to remove all types of small junk objects from the well hole. The tool's main feature is that it eliminates the possibility of pulling a wet string during fishing operation with its reverse drainage design. The RCJB can also be used as a fish magnet when fitted with a magnet insert, while maintaining its reverse fluid circulation feature.

### Operation

TIANHE RCJB is normally attached at the bottom of the fishing string, lowered to a point several feet from the bottom of the well. Begin circulation of the junk basket to wash the hole. Stop circulation and drop the steel ball. (When the steel ball is dropped into the valve seat, reverse fluid circulation is activated. The fluid travels outward and downward through the inner passage of the barrel and out through the vents in the lower end. The fluid is then deflected to the center of the tool and up through the return holes in the upper end of the barrel. The reverse fluid circulation carries the junk into the barrel above the junk catcher. Restart the circulation; slowly rotate the junk basket while lowering the tool until a 10-inch core has been cut. Stop rotation and circulation and pull the tool and junk from the hole.



### Specifications - Reverse Circulation Junk Basket

Model	OD of barrel (mm)	Max. fishing size (mm)	OD of steel ball (mm)	Connection (Box)	Hole size (mm)	Product Code
LL-F86	86	51	23	NC26	92~98	L11-86000
LL-F89	89	57	23	NC26	95~102	L11-89000
LL-F92	92	57	23	NC26	95~102	L11-920000
LL-F101	101	63.5	23	NC26	105~114	L11-101000
LL-F114	114	78	28	NC31	117~127	L11-114000
LL-F123	123	90.5	28	NC31	130~140	L11-123000
LL-F130	130	95	34	NC38	143~152	L11-130200
LL-F146	146	111	34	NC38	155~165	L11-146000
LL-F159	159	121	34	NC46	168~187	L11-159100
LL-F178	178	130	42	NC50	190~210	L11-178000
LL-F200	200	154	42	NC50	212~241	L11-200000
LL-F206	206	157	45	NC50	216~241	L11-206000
LL-F232	232	179	57	NC50	244~270	L11-232000
LL-F257	257	194	57	6 5/8REG	273~295	L11-257000
LL-F279	279	211	57	6 5/8REG	298~317	L11-279000
LL-F301	301	219	57	6 5/8REG	320~346	L11-301000
LL-F330	330	249	57	6 5/8REG	349~406	L11-330000
LL-F381	381	279	57	6 5/8REG	406~444	L11-381000
LL-F508	508	406	57	7 5/8REG	559~660	L11-508000
LL-F559	559	426	57	7 5/8REG	610~711	L11-559000

The TIANHE S-Fishing Magnet is a junk retrieval tool designed to retrieve small metal, odd-shaped objects such as mill metal shavings, bit cones, cutters, bearings, slips, tong pins, and hand tools from the bottom of the well bore. Typically, these damaging junk objects are the result of bit failures, mill cuttings, and fallen un-drillable objects which can only be removed by magnetic attraction. The tool is designed with many fluid circulation ports that wash away cuttings and other debris to prevent any interference with the magnetic contact. A variety of guides are available to aid in different retrieval situation.

### Construction

TIANHE S-Fishing Magnet consists of a top sub, housing, magnet element, pole plate, and standard flush guide. The body is manufactured from high strength alloy steel. The magnet element is a powerful permanent magnet that will not lose its charge when handled properly. The magnet body, housing, and pole plate are threaded and welded together during assembly with the magnet element in place. The standard flush bottom guide is threaded and can be easily removed.

### Operation

TIANHE S-Fishing Magnets are usually run on tubing and drill pipes. With wireline adaptors, it can also be run on wireline. The S-Fishing Magnet is attached at the bottom of the fishing string and lowered until it is six to twelve inches within the fish. Circulate to wash the fish. Reduce circulation and lower the fishing magnet to the fish. Slowly rotate to ensure positive contact. Upon positive contact, stop the circulation and lift the fishing magnet from the hole to retrieve the junk.



Standard Fishing Magnet (L25)



Cut-Lipped Guide



Mill-Type Guide



Wireline Adapter

### Optional Accessories

A flush guide is standard. Lipped guides and mill guides are also available. The lipped guide centralizes the fish to ensure proper direct contact with the magnet. The mill guide enables milling of any soft formation or settling to free debris at the bottom of the hole.

Model 型号	Product Code	O.D. (mm)	Thread Connection	Attracted Weight(KN)	Temperature In well (°C)	Hole Size (mm)
CL38	L25-03800	38	5/8" ROD PIN	≥0.049	<210	φ51~φ70
CL57	L25-05700	57	3/4" ROD PIN	≥0.11	<210	φ70~φ92
CL64	L25-06400	64	3/4" ROD PIN	≥0.22	<210	φ76~φ95
CL70	L25-07000	70	2 3/8" REG PIN	≥0.22	<210	φ86~φ105
CL76	L25-07600	76	2 3/8" REG PIN	≥0.38	<210	φ86~φ105
CL79	L25-07900	79	2 3/8" REG PIN	≥0.38	<210	φ86~φ105
CL83	L25-08300	83	2 3/8" REG PIN	≥0.4	<210	φ95~φ108
CL86	L25-08600	86	2 3/8" REG PIN	≥3	<210	φ95~φ108
CL89	L25-08900	89	2 3/8" REG PIN	≥3	<210	φ100~φ114
CL102	L25-10200	102	2 3/8" REG PIN	≥5	<210	φ110~φ121
CL114	L25-11400	114	2 7/8" REG PIN	≥6	<210	φ121~φ140
CL125	L25-12500	125	2 7/8" REG PIN	≥7	<210	φ143~φ152
CL127	L25-12700	127	2 7/8" REG PIN	≥7	<210	φ143~φ152
CL140	L25-14000	140	3 1/2" REG PIN	≥9	<210	φ152~φ165
CL146	L25-14600	146	3 1/2" REG PIN	≥9	<210	φ160~φ184
CL152	L25-15200	152	3 1/2" REG PIN	≥9	<210	φ168~φ190
CL178	L25-17800	178	4 1/2" REG PIN	≥11	<210	φ190~φ216
CL190	L25-19000	190	4 1/2" REG PIN	≥13	<210	φ203~φ229
CL200	L25-20000	200	4 1/2" REG PIN	≥15	<210	φ216~φ241
CL203	L25-20300	203	4 1/2" REG PIN	≥15	<210	φ219~φ241
CL229	L25-22900	229	6 5/8" REG PIN	≥18	<210	φ241~φ279
CL254	L25-25400	254	6 5/8" REG PIN	≥20	<210	φ267~φ311
CL267	L25-26700	267	6 5/8" REG PIN	≥22	<210	φ279~φ330
CL292	L25-29200	292	6 5/8" REG PIN	≥26	<150	φ311~φ356
CL356	L25-35600	356	6 5/8" REG PIN	≥28	<150	φ381~φ445
CL381	L25-38100	381	7 5/8" REG PIN	≥30	<150	φ406~φ483
CL406	L25-40600	406	7 5/8" REG PIN	≥32	<150	φ432~φ508
CL483	L25-48300	483	7 5/8" REG PIN	≥35	<150	φ508~φ610
CL559	L25-55900	559	7 5/8" REG PIN	≥45	<150	φ610~φ711

TIANHE Reverse Circulation Fishing Magnet is a new fishing tool designed based on TIANHE Standard Fishing Magnet. It combines advantages of Reverse Circulation Fishing Basket and Fishing Magnet. Its unique reverse-circulation design enhances its cleaning performance at the bottom of well bore.

### Construction

TIANHE Reverse Circulation Fishing Magnet comprises of lifting bail, top sub, housing, magnet element, pole plate, standard flush guide, and steel ball. Other optional guides are available for different fishing operations.

### Operation

Lower the fishing magnet to a depth, approximately 40 inches from the bottom of the well bore. Circulate to wash the fish, reduce circulation and lower the fishing magnet to the bottom of hole to attract the fish. Slowly rotate to ensure positive contact between the fish and the magnet. Lift up 10 to 20 inches, drop the steel ball into the fishing string, and pump the steel ball into the valve seat. Rotate and circulate for a moment, discontinue circulation and lift the fishing magnet from the hole.

### Optional Accessories

A flush guide is standard. Lipped guides and mill guides are also available.

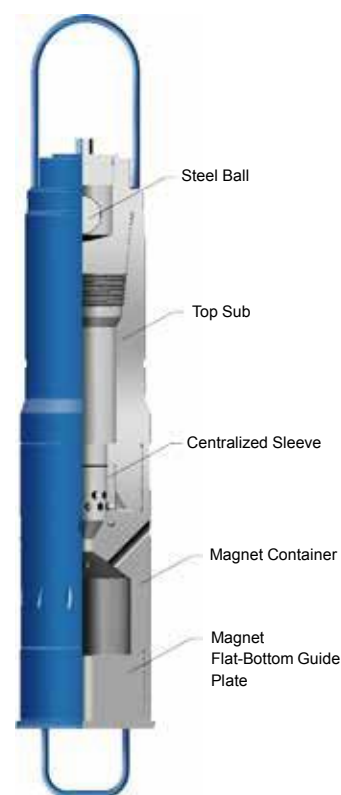

Reverse Circulation  
Fishing Magnet  
(L09)

## Specifications - Reverse Circulation Fishing Magnet

Model	Product Code	O.D. (mm)	Thread Connection	Attracted Weight (KN)	Temperature In well (°C)	Hole Size (mm)
CLF79	L0901100	79	NC23 BOX	≥0.38	<210	φ86~φ105
CLF86	L0902100	86	NC23 BOX	≥3	<210	φ95~φ108
CLF102	L0906100	102	NC26 BOX	≥5	<210	φ110~φ121
CLF114	L0909100	114	NC31 BOX	≥6	<210	φ121~φ140
CLF125	L0912100	125	NC38 BOX	≥7	<210	φ143~φ152
CLF127	L0913100	127	NC38 BOX	≥7	<210	φ143~φ152
CLF140	L0914100	140	NC38 BOX	≥9	<210	φ152~φ165
CLF146	L0915100	146	NC38 BOX	≥9	<210	φ160~φ184
CLF152	L0916100	152	NC38 BOX	≥9	<210	φ168~φ190
CLF165	L0917100	165	NC38 BOX	≥10	<210	φ178~φ203
CLF178	L0918100	178	NC50 BOX	≥11	<210	φ190~φ216
CLF190	L0919100	190	NC50 BOX	≥13	<210	φ203~φ229
CLF200	L0920100	200	NC50 BOX	≥15	<210	φ216~φ241
CLF203	L0921100	203	NC50 BOX	≥15	<210	φ219~φ241
CLF225	L0923100	225	NC50 BOX	≥18	<210	φ241~φ279
CLF254	L0927100	254	6 5/8REG BOX	≥20	<210	φ267~φ311
CLF265	L0928100	265	6 5/8REG BOX	≥22	<210	φ279~φ330
CLF267	L0929100	267	6 5/8REG BOX	≥22	<210	φ279~φ330
CLF292	L0933100	292	6 5/8REG BOX	≥26	<150	φ311~φ356
CLF356	L0937100	356	6 5/8REG BOX	≥28	<150	φ381~φ445
CLF381	L0938100	381	7 5/8REG BOX	≥30	<150	φ406~φ483
CLF406	L0940100	406	7 5/8REG BOX	≥32	<150	φ432~φ508
CLF508	L0941100	508	7 5/8REG BOX	≥40	<150	φ559~φ660

The ditch magnet is the most effective means of trapping and removing metal particles from the drilling mud that are not filtered by the shale shaker. This unit will capture all metals through magnetic attraction and hold them until they can be removed from the mud stream. The magnet is particularly valuable and useful during milling operations. Removal of mill cuttings and debris reduces wear of mud pumps, drill bit and other equipment. It eliminates problems caused by the harmful debris that are returned to the downhole with the drilling mud. They are equally effective during washover and fishing operations.

### Structure

The ditch magnet is made of a high performance magnet with strong magnetic field. It is simple, rugged and has high power to weight ratio.

### Operation

Ditch magnet is easy to operate. It is most effective when suspended by soft line in the mud ditch or shaker discharge. When the cuttings or debris attached are full, it should be removed and cleaned. Remove the magnet from the mud ditch and open the inserting plate from the end with the pull rod. When the magnetic pole body is pulled out, all cuttings and debris will drop off. The magnet body shall be cleaned with fresh water and assemble again for use.

### Maintenance

Frequency of cleaning for the unit per day is directly dependent on the milling rate. Higher milling rate will mean high cleaning frequency. To clean the unit, remove the Magnet and clean it with fresh or salt water hose. Wipe all cuttings from the unit and assemble it back for normal operation. During other operations when there are less return cuttings or metal shavings, the unit need not be cleaned so frequently.



Ditch Magnet  
(L26)

## Specifications - Ditch Magnet

Model	OD (mm)	Magnetic Effective Area(mm)	Strength of Magnetic Pole Surface (Gs)	Strength From 10mm To Magnetic Pole Surface (Gs)	Product Code
18"	200×460	125×400	1400	700	L260100
24"	200×620	125×525	1400	700	L260200
36"	200×920	125×825	1400	700	L260300

### Flat Bottom Junk Mill

The Flat Bottom Junk Mill is the most commonly used milling tool. It is designed to mill a wide variety of junk such as squeeze tools, packers, tubing, bridge plugs and similar objects.



Flat bottom junk mill (M08)

### Tapered Mills

The Tapered Mill is designed for milling through various types of downhole obstructions, and reaming out liners and whipstock windows. It works well in collapsed casing as well as tight spots.



Tapered Mill (M11)

### Concave Junk Mills

The Concave Mill is designed for milling bit cones and other loose objects. It keeps the fish in a centralized fix location under the mill for greater milling effectiveness.



Concave Bottom Junk Mill (M04)

### Economill

The Economill is an effective tool for light duty milling jobs such as packers, bridge plug, and cement. This mill can be easily make-up and break-out with standard bit breakers.



Economill (M25)

### Bladed Junk Mill

Bladed Junk Mill is dressed with high-quality tungsten carbide to ensure optimal performance in all applications. They are suitable for all types of general junk milling, as well as for removing packers, retainers, and squeeze tools.



Bladed Junk Mill (M26)

### String Junk Mill

The String Mill is designed to clean casing and whipstock windows. Its short leading and trailing angles, allow the mill to clean "bird nest" and other obstructions in the string, while the bottomhole tool is milling. This string mill assures that the milled section maintains full gage.



String Junk Mill (M27)

### Pilot Mill

The Pilot Mill is best used for milling stuck tubular tools, such as liner, liner hanger, wash pipe, rotary shoe or drill pipe. The pilot assembly keeps the tubular tools in a centered position, while the milling blades mill the product away.



Pilot Mill (M12)

### Skirted Junk Mill

The Skirted Junk Mill is designed for milling tubular fish, either inside casing or in open hole. Should the fish be plugged, it is far better to use a shoe-type guide with a flat mill to avoid sidetracking.



Skirted Junk Mill (M22)



Junk Sub (Fishing Cup) is normally used to catch and remove junks that are too heavy to be circulated preventing them from settling at the bottom of the well-bore. Typical junks are shivers and fallen objects such as carbide tooth, drill bit and bearings which are too heavy to be removed from the well-hole through conventional fluid circulation. Junk Sub's main function is to keep well bottom clean to increase bit service life, reduce and prevent drill bit from unexpected damage.

### Structure

As the outer diameter of the external bowl is bigger, the space between the external bowl and the well hole is reduced guiding most of the fluid through the cup. The mandrel diameter at the cup mouth is bigger with larger annular space. Thus, the fluid forms a swirl at the cup mouth as the fluid flows down through the cup with a sudden reduction in capacity at the bottom. Through this working principle, some heavy objects will drop in the cup and be fished out, ensuring that the well-bore bottom is cleaned.



Junk Sub  
(L14)

### Specifications - Junk Sub

Model	Bottom Conn. × Top Conn	OD of cup(mm)	OD of upper end	ID (mm)	L of cup(mm)	OAL(mm)	Hole size(mm)	Product Code
LB79	2 3/8REG B*2 3/8REG P	79	79	19	250	845	88.9~98.4	L14-07900
LB89	2 3/8REG B*2 3/8REG P	89	78	19	250	845	108~117.5	L14-08900
LB94	2 3/8REG B*2 3/8REG P	94	79	19	250	850	108~117.5	L14-09400
LB102	2 7/8REG B*2 7/8REG P	102	93.5	31.8	250	850	117.5~124	L14-10200
LB114	3 1/2REG B*3 1/2REG P	115	105.5	38.1	250	915	130~149	L14-11400
LB127	3 1/2REG B*3 1/2REG P	127	108	38.1	250	850	152.4~162	L14-12720
LB133	3 1/2REG B*3 1/2REG P	133	108	38.1	250	875	152.4~162	L14-13340
LB140	3 1/2REG B*3 1/2REG P	140	108	38.1	250	875	165~190.5	L14-14030
LB146	3 1/2REG B*3 1/2REG P	146	108	38.1	250	875	168~190.5	L14-14610
LB165	4 1/2REG B*4 1/2REG P	165	140	57.2	250	915	190.5~216	L14-16510
LB168	4 1/2REG B*4 1/2REG P	168	140	57.2	250	915	190.5~216	L14-16820
LB178	4 1/2REG B*4 1/2REG P	178	146	57.2	250	915	219~244.5	L14-17830
LB194	4 1/2REG B*4 1/2REG P	194	146	57.2	250	950	229~273	L14-19410
LB200	4 1/2REG B*4 1/2REG P	200	146	57.2	250	950	229~273	L14-20000
LB219	6 5/8REG B*6 5/8REG P	219	197	76.2	250	950	244~289	L14-21930
LB241	6 5/8REG B*6 5/8REG P	241	197	76.2	250	950	292~330	L14-24110
LB245	6 5/8REG B*6 5/8REG P	245	203	76.2	250	950	292~330	L14-24510
LB245	6 5/8REG B*6 5/8REG P	245	197	88.9	250	940	292~330	L14-24530
LB273	6 5/8REG B*6 5/8REG P	273	203	76.2	250	950	330~375	L14-27300
LB286	6 5/8REG B*6 5/8REG P	286	203	76.2	250	1000	330~375	L14-28600
LB327	7 5/8REG B*7 5/8REG P	327	241.3	76.2	250	1050	375~444.5	L14-32730
LB327	7 5/8REG B*7 5/8REG P	327	225.4	102	250	1000	375~444.5	L14-32740
LB340	7 5/8REG B*7 5/8REG P	340	225.4	76.2	250	1080	381~444.5	L14-34000
LB381	7 5/8REG B*7 5/8REG P	381	241.3	76.2	250	1065	432~508	L14-38100
LB473	7 5/8REG B*7 5/8REG P	473	241.3	76.2	250	1120	508~559	L14-16820

Washover pipe is a special tool commonly used to release stuck section of drill string in the well bore. TIANHE offers a complete range of washover pipe for the industry. TIANHE provides a unique FJWP thread that adopts a two-step double shoulder threaded connection which assures quick make up and high torsional strength.

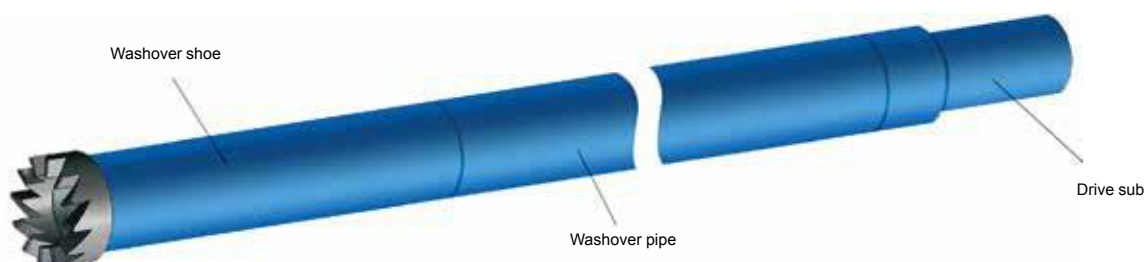

## Specifications - Washover Pipe

Model	Product Code	O.D	I.D	Wall Thickness	Min. Hole Size	Max. Mill Size	Max. Tensile Load kN	Connection Field Torque N.m	Seal Pressure MPa.
TXG95.3	L21-113	95.3	82.6	6.35	105	79.4	180	4070	20
TXG 101.6	L21-123	101.6	84.6	8.5	114.3	82.5	355	6750	20
TXG 114.3	L21-133	114.3	99.6	7.36	120.7	95.3	345	6780	20
TXG 114.3	L21-143	114.3	97.2	8.56	120.7	93.7	390	9490	20
TXG 127	L21-153	127	108.6	9.19	146.1	104.8	440	12202	20
TXG 139.7	L21-163	139.7	124.3	7.72	152.4	121	460	12200	20
TXG 139.7	L21-173	139.7	121.4	9.17	152.4	117.5	500	14914	20
TXG 139.7	L21-183	139.7	118.6	10.55	152.4	114.3	550	17630	20
TXG 146	L21-193	146	130.2	7.92	162	127	500	14914	20
TXG 146	L21-203	146	128.1	9	162	121	560	16269	20
TXG 152.4	L21-213	152.4	136	8.25	178	133.3	525	16270	20
TXG 168.3	L21-223	168.3	150.4	8.94	187.3	146	600	21693	15
TXG 177.8	L21-233	177.8	159.4	9.19	200	152.4	640	24404	15
TXG 193.7	L21-243	193.7	174.6	9.53	212.7	171.5	700	31183	15
TXG 193.7	L21-253	193.7	171.8	10.92	212.7	168.3	810	36607	15
TXG 193.7	L21-263	193.7	168.3	12.7	212.7	165	1060	43386	15
TXG 203.2	L21-273	203.2	184.2	9.53	216	181	820	32539	15
TXG 206.4	L21-283	206.4	187.6	9.4	216	184.2	830	32539	15
TXG 206.4	L21-293	206.4	185.1	10.67	216	181	905	40680	15
TXG 206.4	L21-303	206.4	182.5	11.94	216	179.4	1025	47460	15
TXG 219	L21-313	219	196.2	11.43	244.5	195.3	1100	47453	15
TXG 219	L21-323	219	193.7	12.7	244.5	192	1220	54232	15
TXG 228.6	L21-333	228.6	207	10.8	250.8	203	1260	47453	15
TXG 244.5	L21-343	244.5	220.5	11.99	266.7	215.9	1460	67791	15
TXG 244.5	L21-353	244.5	216.8	13.84	266.7	206.4	1560	81349	15
TXG 273	L21-363	273	250.2	11.43	298.5	244.5	1620	81349	15
TXG 273	L21-373	273	247.9	12.57	298.5	241.3	1640	88128	15
TXG 298.5	L21-383	298.5	273.6	12.42	323.9	266.7	1800	108465	10
TXG 339.7	L21-393	339.7	313.6	13.06	365.1	304.8	2020	149140	10
TXG 406.4	L21-403	406.4	373.1	16.66	444.5	356	2500	254894	7

### Drive Sub

Drive Sub provides the crossover connection between fishing string and the washover pipe. Each sub is machined from high-grade alloy steel and heat treated to provide maximum strength and durability.



Drive Sub

### Lift Plug

Lift Plug is designed to provide an economical method of handling washover strings. It is available in all thread types and sizes to support all connections. In addition, it has sufficient shoulder diameter to support and ensure proper handling of the washover string.



Lift Plug

### Washover Safety Joint

Washover safety joint is manufactured to provide safe and easy make-up and release of washover tools whenever disengagement of washover string is necessary. This dependable, rugged tool is designed for tough field applications to transmit torque in either direction when placed in the washover string.



Washover Safety Joint

### Rotary Shoes

Rotary Shoes are manufactured from specially heat treated alloy to provide ultimate toughness and durability. They are used to cut and create a clearance between the fish and the wall of the well bore.



Rotary Shoe

The ND-J type internal cutter is a down-hole mechanical cutting tool designed to cut casings, tubings and drill pipes. The main advantages are its simple structure, reliable performance and high cutting efficiency. In order not to cut the casing and tubing couplings, the cutter shall be kept away from these couplings during operation. Depending on drilling conditions, it can be used in conjunction with coupling locator to locate the position of the nearest coupling from the cutter. When the internal cutter is used with the releasing spear, it can cut and remove the cut tubing in one fishing operation. Alternatively, a separate fishing tool can be used to remove cut pieces.

### Working Principle

Lower the internal cutter to a designated cutting depth, rotate (3 rounds) the cutter mandrel in the clockwise direction to separate the sliding sleeve and the sliding sheet. At this instance, with the spring effect, the friction block will be pressed against the pipe wall. In addition, due to the engagement of the sliding sleeve and sheet, the main center body and the slip portion is pushed upwards along the tapered slip cone, expanding the slip diameter. As the slip diameter expands, it bites on the internal wall of the drill pipe. At this moment, anchor the cutter on the pipe wall and lift the cutter mandrel by 10mm. After which, slowly lower and rotate mandrel, as the cutters (3 pcs) move down the tapered cutter block, it open up radially to cut the pipe wall.

The cutting operation is completed when the mandrel pressed against the end of the thrust ring. Lift the mandrel to release and reposition the cutters via its own weight and the function of the blade spring. As the mandrel is lifted, the sliding sleeve and sheet re-engage back to its original position. In addition, as the tapered slip cone moves upwards, the slip loses its grip on the pipe wall and the cutter releases its anchor on the wall. Continue to lift mandrel until the locating ring engages with the guide nut before pulling the tool out.

### When ordering please specify:

- Pipe size and weight to be cut.
- Top connection.



Mechanical Internal Cutter  
(x04)

### Specifications - Mechanical Internal Cutter

Model	Product Code	O.D. 外径(mm)	Connection (mm)	ID (mm)	ID of cut pipe(mm)	Weight Pipe(ib/ft)
ND-J73×55	X04-73000	55	1.9 NU	8	59~62	6.4 ~ 7.9(2 7/8 TBG)
ND-J89×68	X04-89100	68	1.9EU	13	74.2~78	7.7 ~ 10.2(3 1/2 TBG)
						9.5(3 1/2D.P.)
ND-J114×91	X04-114000	91	NC26	16	97~104	12.6 ~ 15.2(4 1/2 TBG)
						9.5 ~ 15.1(4 1/2CSG)
						13.75 ~ 16.6(4 1/2D.P.)
ND-J114×89	X04-114100	89	NC26	16	95~104	12.6 ~ 17(4 1/2 TBG)
						9.5 ~ 16.9(4 1/2CSG)
						13.75 ~ 16.6(4 1/2D.P.)
ND-J127×102	X04-127000	102	NC26	18	108.6~116	11.5 ~ 18(5CSG)
						19.5(5 D.P.)
ND-J127×96	X04-127100	96	NC26	16	103-116	11.5 ~ 23.2(5CSG)
						19.5(5 D.P.)
ND-J140×108	X04-140200	108	NC31	18	108.6~116	14 ~ 23(5 1/2CSG)
						21.9 ~ 24.7(5 1/2D.P.)
ND-J178×145	X04-178300	145	NC38	38	152.5~161.7	23 ~ 35 (7 CSG)
ND-J203×167	X04-203100	167	NC50	44	183~193.7	16 ~ 26 (8 CSG)
ND-J219×181	X04-219100	181	NC50	44	190.7~205.6	24 ~ 49 (8 5/8 CSG)
ND-J245×203	X04-245100	203	NC50	50	216.8~228.6	32.3 ~ 53.5 (9 5/8 CSG)
ND-J273×228	X04-273100	228	6 5/8REG	57	242.8~252.7	45.5 ~ 65.7 (10 3/4 CSG)
ND-J340×298	X04-340100	298	6 5/8REG	76	313.6~323	48 ~ 72 (13 3/8 CSG)

TIANHE Multi-string Cutter is built to withstand extreme shock encountered while cutting multiple strings of un-centralized conductor pipes. The unique construction of this tool enables the rugged cutter arms to expand outward up to 5 times the diameter of the tool body. The cutter can achieve maximum stability under all types of adverse cutting conditions, including hard spots, eccentricity, interrupted cuts, etc.

For example, a 13 3/8" casing cutter, the diameter is only 11 3/4". However it can handle and cut a wide range of pipes with varying weights up to a 60" diameter.

### Features and Benefits

- Cuts multiple strings smoothly, even when the strings are not concentric;
- Support maximum expansion of blades, up to 5 times body diameter;
- Rugged 3-bladed construction provides fast cut at high speed;
- Cutter arms can be changed on rig floor.

### When ordering please specify:

- Casing size or range to be cut;
- Top connection;
- Body OD.

### Specifications - Multi-String Cutter

表 1 NDD 型 水利式多层套管割刀

O.D ( mm )	Connection	Casing O.D ( in )		Product Code
		Min.	Max.	
102	2 7/8REG	5	9 5/8	G0112700
111	2 7/8REG	5 1/2	9 5/8	G0114000
133	NC38	6 5/8	16	G0116800
146	NC38	7	16	G0117800
203	6 5/8REG	9 5/8	30	G0124500
210	6 5/8REG	9 5/8	30	G0124510
238	6 5/8REG	10 3/4	36	G0127300
298	6 5/8REG	13 3/8	60	G0134000
368	6 5/8REG	16	60	G0140600



Multi-String Cutter  
(G01)

表 2 切刀代号及切割套管范围

NDD140×111	NDD168×133	NDD178×146	NDD245×203	NDD245×210	NDD273×238	NDD340×298	NDD406×368
NDD140×111-01A5 1/2	NDD168×133-01A6 5/8	NDD178×146-01A7	NDD245×210-01A 9 5/8	NDD245×210-01A 9 5/8	NDD273×238-01A 10 3/4~11 3/4	NDD340×298-01A 13 3/8~16	NDD406×368-01A 16
NDD140×111-01B5 1/2~7	NDD168×133-01B7~9 5/8	NDD178×146-01B7~9 5/8	NDD245×210-01B 10 3/4~13 3/8	NDD245×210-01B 10 3/4~13 3/8	NDD273×238-01B 10 3/4~16	NDD340×298-01B 13 3/8~20	NDD406×368-01B 16~20
NDD140×111-01C5 1/2~9 5/8	NDD168×133-01C9 5/8~11 3/4	NDD178×146-01C9 5/8~11 3/4	NDD245×210-01C 10 3/4~16	NDD245×210-01C 10 3/4~16	NDD273×238-01C 10 3/4~20	NDD340×298-01C 13 3/8~30	NDD406×368-01C 16~30
	NDD168×133-01D11 3/4~16	NDD178×146-01D11 3/4~16	NDD245×210-01D 13 3/8~20	NDD245×210-01D 13 3/8~20	NDD273×238-01D 10 3/4~30	NDD340×298-01D 20~36	NDD406×368-01D 20~36
			NDD245×210-01E 20~30	NDD245×210-01E 20~30	NDD273×238-01E 20~36	NDD340×298-01E 30~60	NDD406×368-01E 30~60

Section mills are primarily used to milling sections in the casing (for side tracking, gravel packing) and perforation zones. TIANHE section mill is available in a variety of Casing sizes, ranging from 4 1/2" to 13 3/8". The blades are all dressed to enable simultaneously milling of the casing. The milling rate is usually limited by the ability of the fluid in removing the cuttings.

#### When ordering please specify:

- Tool model
- Size and weight of Casing to be milled
- Top connection



Section Mill

#### Specifications - Section Mill

Model	Connection	Body O.D ( mm )	Max. OD when cutter opened ( mm )	OD of stabilizer block		Casing Size ( in )	Product Code
				Casing wallthickness( mm )	OD of stabilizer block ( mm )		
DX114	2 3/8 REG	96	130	5.2	100	4 1/2	D111400
				5.68	99		
				6.35	98		
DX127	2 7/8 REG	104	150	5.59	112	5	DX112700
				6.43	111		
				7.52	108		
DX140	2 7/8 REG	114	165	6.2	124	5 1/2	DX114000
				6.98	122		
				7.72	121		
DX168	3 1/2 REG	140	200	7.32	150	6 5/8	DX116800
				8.94	147		
				10.59	144		
				12.06	141		
DX178	3 1/2 REG	152	215	8.03	158	7	DX117800
				9.19	156		
				10.36	154		
DX245	4 1/2 REG	210	310	7.92	225	9 5/8	DX124500
				8.94	223		
				10.03	221		
				11.05	218		
DX340	6 5/8 REG	292	394	11.99	216	13 3/8	DX134000
				8.38	319		
				9.65	316		
				10.92	314		
				12.19	311		
				13.06	309		



H type safety joint, is an essential safety tool for sub-surface drilling. It is built to withstand all kinds of loads (axial pulling or pressing) and it aid in torque transmission. In downhole operations, safety joints are normally added to the drill string as a precaution to support any tool recovery emergencies. The safety joint allows quick release and disengagement of the tool should they become stuck, so that the drill stem above can be removed. On top of that, while resuming the downhole operation, the safety joint ensures quick and easy **to reconnect** of drill stem.

### Specifications - H Type Safety Joint

Model	Product Code	O.D. (mm)	I.D. (mm)	Thread Connection
HAJ89	A020890	89	15	NC26
HAJ95	A020950	95	20	NC26
HAJ105	A021050	105	30	NC31
HAJ121	A021210	121	38	NC38
HAJ159	A021590	159	50	NC46 , NC50
HAJ165	A021650	165	50	NC46 , NC50
HAJ178	A021780	178	57	NC50 , 5 1/2 FH
HAJ203	A022030	203	71.4	6 5/8 REG



Type H Safety Joint  
(A02)

## TYPE AJ SAFETY JOINT

AJ type safety joint is a specialized joint consisting of two parts. This specialized joint protects the drilling stem during drilling, fishing, repairing and testing operations. It is used to handle and manage well bottom accident. During drilling and coring operations, it is connected to the required position of drilling stem to protect the drilling stem without any influence on the normal working of drilling tool.

### Specifications - AJ Type Safety Joint

Model	Product Code	O.D. (mm)	I.D. (mm)	Thread Connection
AJ-C86	A010860	86	38	NC26
AJ-C95	A010950	95	44	NC26
AJ-C105	A011050	105	51	NC31, 2 7/8 NU, 2 7/8 EUE
AJ-C121	A011210	121	57	NC38
AJ-C159	A011590	159	71.4	NC46 , NC50
AJ-C165	A011650	165	71.4	NC50
AJ-C178	A011780	178	71.4	NC50 , 5 1/2 FH
AJ-C203	A012030	203	76	6 5/8 REG
AJ-C228	A012280	228	76	7 5/8 REG



Type AJ Safety Joint  
(A01)

Impression Block is an effective tool used to determine the dimensions, configuration, condition, and location of the top end of a fish in the hole.

#### Construction

TIANHE Impression Blocks are manufactured with a high strength alloy steel body and a soft lead insert at the lower end. All impression blocks come with a watercourse that allows flushing of the fish top before the tool is lowered against it. Impression blocks without a watercourse can be furnished upon request.

#### Operation

Attach the impression block to the bottom of the fishing string and lower into the well-hole. Do not rotate the tool, slowly lower the impression block to the point of contact with the fish. Apply weight on the impression block to make an imprint of the fish on the soft lead insert and lift it from the hole.

#### When ordering, please specify:

- Complete assembly or part number
- Top connection
- Lead O.D.



Impression Block  
(X03)

#### Specifications - Impression Blocks

Model	O.D(mm)	I.D(mm)	Thread connection(BOX)	Casing/tubing Size(in)	Code
QM79	79	12	NC23	4	X03-7900
QM89	89	12	NC26	4 1/2	X03-8900
QM98	98	12	NC26	5	X03-9800
QM110	110	12	NC31	5 1/2	X03-11000
QM146	146	20	NC38	7	X03-14600
QM203	203	25	NC50	9 5/8	X03-20300
QM305	305	38	6 5/8REG	13 3/8	X03-30500

Hydraulic Make/Break Unit is important for make-up, break-out and maintenance of drilling tools and motors in both the workshop and drill sites. CZJ-I Hydraulic Make/Break Unit is designed and manufactured to cater to the needs of both China and overseas rig operators in the petroleum industry. The design was awarded the status of new High-Tech Product and has obtained several Patented Protection Rights in China. CZJ-I Hydraulic Make/Break Unit's proven technology has been well received by the international market.

CZJ-I Hydraulic Make/Break Unit is a highly automated and self-contained hydraulic make-up and break-out machine. It has high make-up/break-out torque, supports a wide range of pipe diameter and is specially designed to reduce the risk of slippage during make/break operations.

CZJ-I Hydraulic Make/Break Unit comes with the option of Hydraulic Push/Pull Assembly and Hydraulic Spinner (Quick Rotary) Assembly. The Push/Pull Assembly supports axial loading where push/pull force is required and is generally used in the maintenance of mud motors to insert or remove rotors from stators. The hydraulic spinner ensures quick spin up / spin out of low torque shouldered connections.

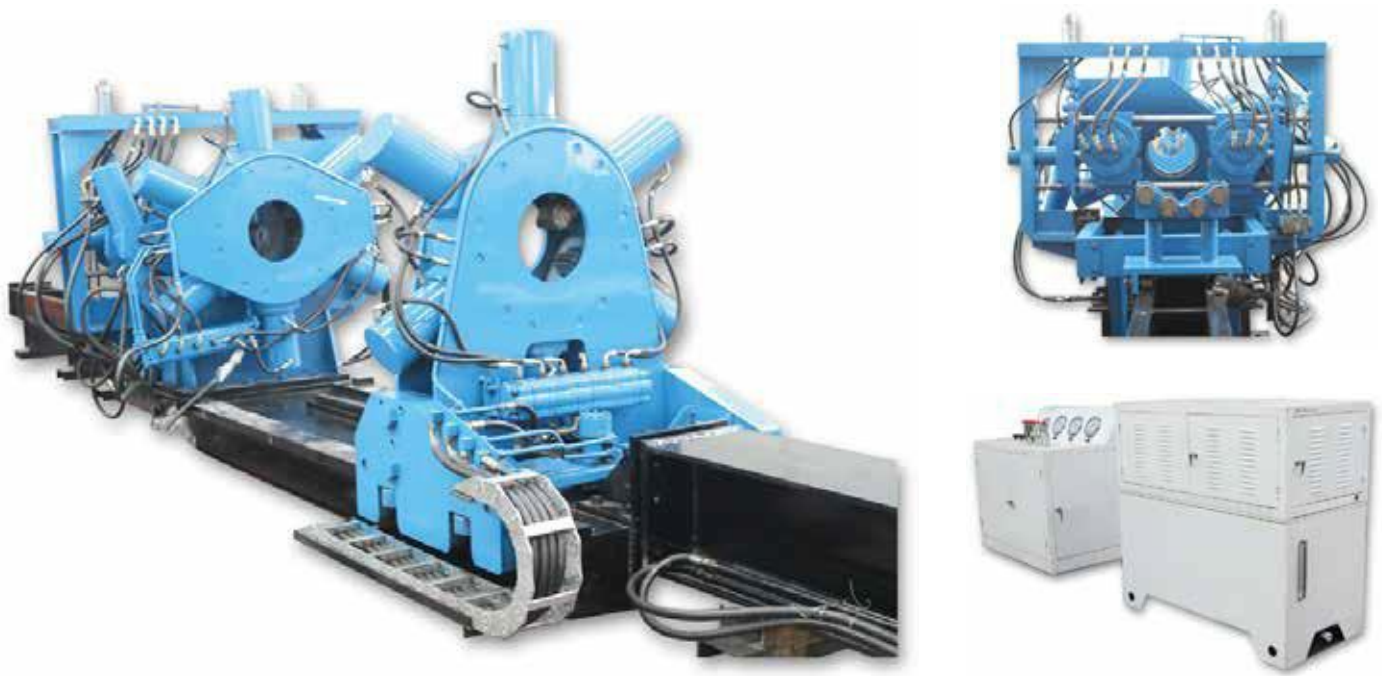

CZJ-I Bucking Unit (E11)

### Specifications - CZJ-I Hydraulic Bucking unit

Model	Product Code	Motor Power (KW)	Clamp Pipe Dia. Range (mm)	Max. Makeup Torque (KN·m)	Max. Breakout Torque (KN·m)	Pipe Dia. For Quick Makeup / Breakout unit(mm)	Motor Speed (rpm)	Max. Working Pressure (MPa)	Quick Makeup / Breakout unit Torque (KN·m)	Max. Tons For Push/Pull Cylinder (KN)	Stroke For Push/ Pull Cylinder (mm)
CzJ320I	E11110000	15	Φ73-310	10-118	168	Φ73-340	1460	12	2.5-4.0	150	1500
CzJ400I	E11210000	15	Φ73-390	15-150	180	Φ73-340	1460	12	2.5-4.0	150	1500

CZJ-400IS Open Type Quick-Rotary Hydraulic Bucking Unit is the Hydraulic Make/Break Unit with an Open Type Hydraulic Spinner (Quick-Rotary) Assembly. Open Type Quick Rotary Spinner enables easy loading and unloading of tools during operation. The ease of operation greatly improves work efficiency, and reduces the risk of tools damage due to collision.



CZJ400IS Type Open Quick-Rotary Bucking Unit (E12)

### Specifications - Open Type Quick-rotary Hydraulic Bucking unit

Model	Product Code	Motor Power (KW)	Clamp Pipe Dia. Range (mm)	Max. Makeup Torque (KN•m)	Max. Breakout Torque (KN•m)	Pipe Dia. For Quick Makeup / Breakout unit(mm)	Motor Speed (rpm)	Max. Working Pressure (MPa)	Quick Makeup / Breakout unit Torque (KN•m)	Max. Tons For Push/Pull Cylinder (KN)	Stroke For Push/ Pull Cylinder (mm)
CzJ400IS	E12210000	22	Φ73-390	10-118	168	Φ102-390	1460	12	1.5-3	130	1500

## CZJ320W HYDRAULIC BUCKING UNIT

CZJ320W Hydraulic Bucking Unit is specifically designed to cater to the structures and mechanical features of completion tools. It offers the most precise and efficient means of achieving proper make-up/break-out torque either on or off the rig floor for completion tools, drilling tools, oil recovery tools, geological tools and other thin-walled tubes. One of the main advantages of CzJ-320W is the design whereby the clamping force is proportional to the torque provided. Moderate clamp force, small make-up torque and its clamp diameter range makes it suitable for make-up and break-out of completion tools.



CZJ320W Hydraulic Bucking Unit (E14)

### Specifications - CZJ320W Hydraulic Bucking unit

Model	Product Code	Motor Power (KW)	Clamp Pipe Dia. Range (mm)	Max. Makeup Torque (KN•m)	Max. Breakout Torque (KN•m)	Pipe Dia. For Quick Makeup / Breakout unit (mm)	Motor Speed (rpm)	Max. Working Pressure (MPa)	Quick Makeup / Breakout unit Torque (KN•m)	Max. Single Cylinder Clamp Force(KN)
CZJ320W	E14100000	18.5	Φ73-300	3.5-40	60	Φ95-310	1460	12	1.5-3	100

KCZJ400 Flip Type Full Hydraulic Bucking Unit is important for make-up, break-out and maintenance of drilling tools and motors in either the workshop or drill sites. KCZJ400 Flip Type Hydraulic Make/Break Unit is designed and manufactured to cater to the needs of both China and overseas rig operators in the petroleum industry. The unique feature of this unit is in the design of the Tailstock Clamping Cylinders. The tailstock clamping cylinders have adjustable tongs which can be flipped open from the top. During operation the adjustable tongs allow easy loading and unloading of tools. The tools can be directly placed within the clamps from the top and this enables the unit to handle and clamp tools of bigger diameter compared to the clamp's local diameter.



KCZJ400 Flip Type Hydraulic Bucking Unit(E13)

### Specifications - KCZJ400 Flip Type Hydraulic Bucking unit

Model	Product Code	Motor Power (KW)	Clamp Pipe Dia. Range (mm)	Partial Dia. Range Of Make-up / Break-Out (mm)	Max. Makeup Torque (KN·m)	Max. Breakout Torque (KN·m)	Pipe Dia. For Quick Makeup / Breakout unit(mm)	Motor Speed (rpm)	Max. Working Pressure (MPa)	Quick Makeup / Breakout unit Torque (KN·m)	Max. Tons For Push/Pull Cylinder (KN)	Stroke For Push/ Pull Cylinder (mm)
KCZJ400	E13210000	18.5	Φ73-350	1000	15-120	160	Φ73-340	1460	12	2.5-4.0	150	1500

## CZPT-II HYDRAULIC MAKE-UP/BREAK-OUT PLATFORM

CZPT-II Hydraulic make-up/break-out platform is mainly used with Make/Break unit assisting in the pre-assembly of drilling tools, whereby special guiding and alignment of tools are required for proper locking and unlocking of threads during assembly. The precision of tool alignment is the key to fast and accurate make-up and break-out of tools either in the workshop or on the rig. CZPT-II is generally designed to support all types of Make-up/Break-out Unit for its pre-assembly tool alignment and thread guiding. CZPT-II ensures high production efficiency during make-up/break-out of tools.

This device adopts the working design of industry's push/pull assembly. It is highly automated, supports a wide range of tools and tube diameter (Φ62-260mm) in thread guiding and tool alignment. In order to ensure maximum protection of work piece surface during operation, the unit uses special rotary screw clamps (quick-rotary screw tongs) with no teeth marks. It's ease of operation and maintenance help users save operating cost and time.



CZPT-II Hydraulic Make-up/Break-out Platform (E5)

### Specifications - CZPT-II Hydraulic Make-up/Break-out Platform

Max. Rated Working Pressure (MPa)	Product Code	Make-up/Break-Out Torque Of Rotary Screwing Tongs (n·M)	Clamping Dia. Range Of Clamping Tongs (mm)	Clamping Dia. Range Of Rotary Screwing Tongs (mm)	Motor Power (KW)
10	E51110000	0-2506	Φ62—Φ260	Φ62—Φ260	11



CZJQZ-II 360° Rotation Hydraulic Make/Break unit is designed to safely and efficiently make-up/break-out downhole tools and motors. It adopts a unique 360° rotational headstock clamp design. This unit is designed for fast, accurate and dependable make up and break out of threaded connections. The 360° rotational clamp design greatly enhances the speed and accuracy of make-up and break-out of tools.

**FOLLOWING ARE THE ADVANTAGES OF HAVING 360° CONTINUOUS ROTATIONAL HEADSTOCK:**

1. Synchronized gripping force:- The headstock and tailstock each contain five radially arranged heavy duty clamping cylinders (imported). It's designed to ensure a continuous clamping range so as to achieve synchronized gripping force on the tools and precise axial alignment of the tools.
2. Enhanced work efficiency:- The 360° continuous rotational headstock enables the make-up and break-out of tools approximately 18 times faster than normal conventional headstock design which are limited to a 40° rotation per time.
3. Reduces damage on work piece:- With the unique continuous rotational feature, only one clamping action is required to achieve a 360° locking / unlocking of the thread. This greatly reduces the number of times the work piece has to be clamped, thus reducing clamping teeth marks and damage on the surface of the work piece.
4. Precise Torque Application:- Fully imported hydraulic system ensures the accuracy of force applied on each piston cylinder, thus ensuring the precision of torque force on the tools during make-up and break-out.

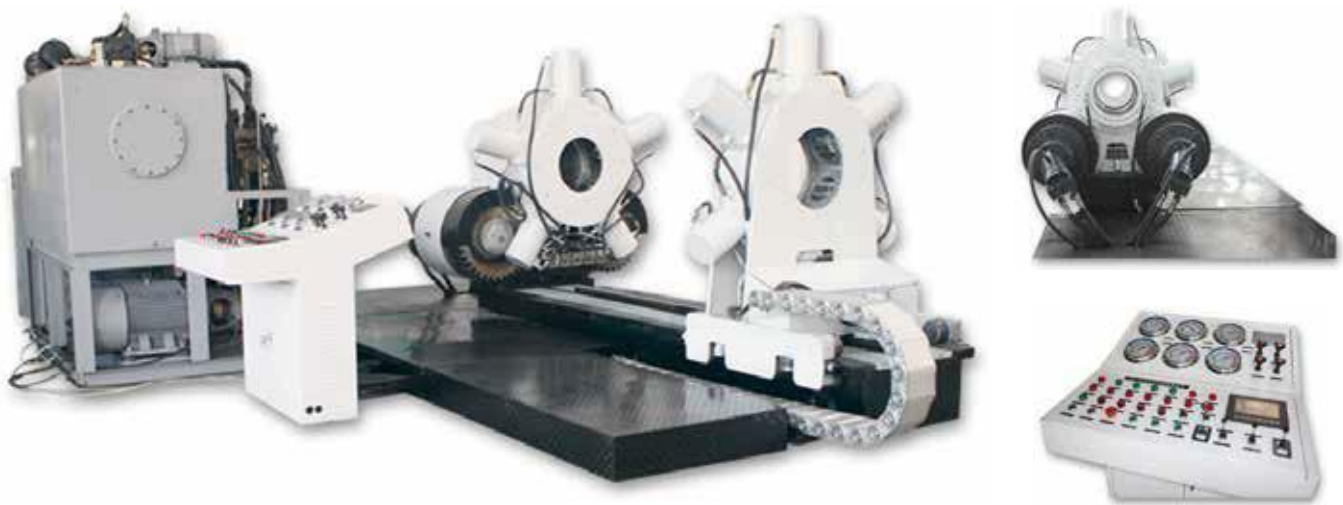

CZJQZ-II Type 360° Rotation Hydraulic Bucking Unit (E15)

**Specifications - CZJQZ-II Type 360° Rotation Hydraulic Bucking unit**

Product Code	Max. Rotary Screwing Torque	Rotary Screwing Speed	Dia. Range Of Work-Pieces	Motor Power	Rotary Screwing Motor Rated Working Pressure
15320000	135Kn•M	0 - 6 r/min	Φ73 - Φ350 mm	67 KW	18 MPa



Downhole motor tester is designed to test the seal performance of new and refurbished downhole motors in the workshop or at the rig site. It serves as a quick verification tool for new and refurbished downhole motor to ensure that it's within specification and in working order before operation in the rig. The tester consists of a tool support structure, water supply system, hydraulic system and control system. The tester is highly automated, easy to operate and support a wide range of downhole motors and tools.

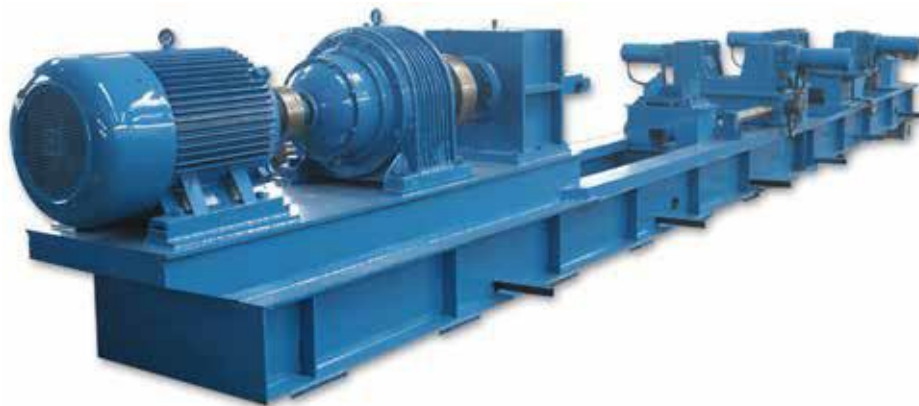

LMST- II Downhole Motor Tester (E4)

### Specifications - LMST-II Downhole Motor Tester

Product Code	Main Motor Power	Hydraulic Pump Motor Power	Driving Speed	Application Dia. Range	Max. Torque	Working Pressure Of Water System	Max. Working Pressure Of Hydraulic System
E41210000	75KW	11KW	40 r /min	Φ89~Φ290	15000n•m	8MPa	20MPa

## SYJ HYDRAULIC JAR TESTER

SYJ Hydraulic Jar Tester is a self-contained unit designed to test the tensile strength and pressure performance of Jars, Absorbers and Jars Intensifiers. In addition, it can be used to test the strength of thread connection on downhole drilling tools. Tester has high safety feature and is designed to handle big push/pull tonnages. It's ease of operation and maintenance help users save operating cost and time.



SYJ Hydraulic Jar Tester (E3)

### Specifications - SYJ Hydraulic Jar Tester

Model	Product Code	Motor Power (KW)	Motor Speed (r/Min)	Max Pressure (MPa)	Max Work Pressure (MPa)	Oil Tank Capacity (L)	Max Push(T)	Max Pull(T)	Test Tool Length Range (m)
Sy J150	E31100000	15	1460	31.5	20	400	150	130	1-9m
SyJ150B	E31200000	15	1460	31.5	20	400	150	130	1-10m
SyJ150C	E31300000	15	1460	31.5	20	400	150	130	1-11m

DYNJ-200/20 Type Hydraulic Screwing Machine is mainly used in the production of Tubing, Casing and Couplings. The unit is normally used to make-up/break-out couplings of casing, tubing and pipes and it supports different type of thread connection. The equipment is a self-contained unit, with its mechanical, electrical and hydraulic system fully integrated as one. The equipment allows real time monitoring and control via the computer console.

The unique star clamping structure of the main and passive tongs allows the machine to service a bigger catch range. With this design, better work efficiency is achieved as changing of teeth block is not necessary for nominal catch size. In addition, the operational speed is adjustable and it adopts an automatic control system which prevents equipment wear and ensures longer service life.



DYNJ-200/20 Type Hydraulic Screwing Machine (E2)

### Specifications - DYNJ-200/20 Type Hydraulic Screwing Machine

Model	Product Code	Max. Rated Torque (Kn·m)	Max. Dia. (mm)	Application Range (mm)	Rated Pressure(MPa)	Power(KW)
DynJ-200/20	E21110000	20	200	Φ60 --196	12	18.5
DynJ-260/20	E21120000	20	260	Φ114-255	12	18.5
DynJ-380/35	E21230000	35	380	Φ140 --370	12	22

## SXL AUTOMATIC LOADING AND UNLOADING MACHINE

SxL automatic loading and unloading machine is used for automated loading and transportation of drilling tools and casing during the production processes, supporting tools with diameter in the range of 2-7/8" to 9-5/8". It supports automatic reclaiming, feeding and clamping of tools during the manufacturing processes. This device consists of an electric-hydraulic control system, and has a stand along electrical console. It is easy to operate, safe and reliable. It helps to save labor cost, improve efficiency and reduce production costs for enterprises.



SXL Type Hydraulic Automatic Loading and Unloading Machine (E6)

### Specifications - SXL Automatic Loading and unloading Machine

Product Code	Motor Power(KW)	Motor Revolution Speed (r/min)	Roller Motor Power (KW)	Dia. Range of Clamping Work Pieces (mm)	Max. Supporting Load (Kg)
E61110000	7.5	1440	1.5	70-245	6000

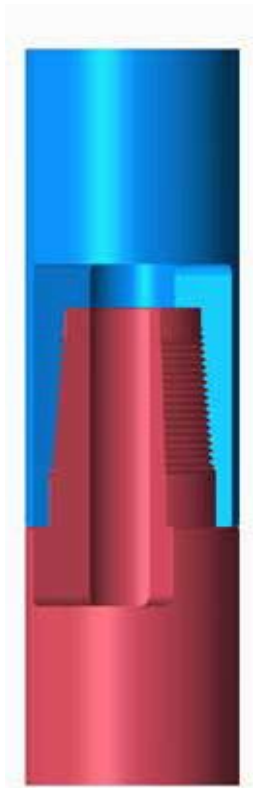

TT Threaded  
Connection

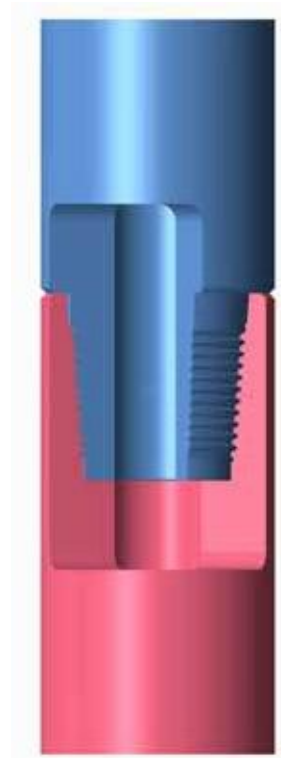

THDS Threaded Connection

Under challenging well conditions, drilling tools are often subjected to high torsional stress, resulting in premature failure and drilling accidents. To cater for these applications, TIANHE has introduced two types of high torque double shoulder threaded connections (TT Type and THDS Type).

#### **Features of TT type double shoulder threaded connection:-**

1. Higher torsional strength and bending stiffness
2. Even distribution of force on the threads
3. Tool joints with double shoulder threaded connections are more rigid, stronger and has greater torque capacity
4. Smooth transition between the pin and box threaded connections, creates a streamlined ID profile. This allows smoother fluid flow during drilling with minimized turbulence, improving the hydraulic performance, minimizing thread erosion and reducing drill collar failure
5. Excellent sealing performance

#### **Features of THDS type double shoulder threaded connection:-**

1. High torsional resistance
2. Interchangeable with API connections of comparable sizes
3. Excellent sealing performance
4. Minimize pressure loss

TIANHE has distinct department for the quality inspection, metering and material testing. We have equipment like metalscopes, profile projectors and carbon and sulfur analyzers which were made in Germany, Japan and Taiwan. All the facilities keep our quality control system's leading position in China and abroad.



① Rockwell hardometer can be used to test material samples'Rockwell hardness.

② Global performance 12.30.10 moving bridge three-coordinate measuring machine.

③ Metalloscope is used for testing and analysis of metal's metallurgical structure. Before and after heat treatment, the metalloscope is used to analyze the microstructure of the metal and the quality of carburization.



④ Impact testing machine is necessary in testing mechanical properties of the products and impact value of Akv.

⑤ Universal testing machine is used to test the tensile strength, yield strength, compressive strength, extensibility and shrinkage of materials. Universal tester can also provide different type of bending or flex test.

⑥ Benchtop OES Metal Analyzer is used for testing and analysis of material sample.



⑦ Magnetic powder flaw detector provides surface inspection of material with fluorescent magnetic particle. It detects and highlights any defects on the surface.

⑧ Profile Projector in the lab provides geometry test for inspection tools and cutters. They are regarded as a precision measuring device in quality control.

⑨ Metalloscope is used for testing and analysis of metal's metallurgical structure. Before and after heat treatment, the metalloscope is used to analyze the microstructure of the metal and the quality of carburization.